

Delcam
ArtCAM
insignia



ArtCAM Insignia 2010 Training Course

Delcam plc,
Talbot Way, Small Heath Business Park, Birmingham, B10 0HJ.
www.delcam.com

Important Notice

This document is supplied as part of a Delcam Training Course. It is not intended to be distance-learning material: rather as an aid for Tutors when presenting material to course delegates and as a subsequent aid memoir to those delegates.

Delcam does not accept responsibility for any personal belongings / valuables whilst on the premises. Delegates are advised to keep their belongings on their person at all times.

Delcam plc. has no control over the use of the software described in this document and cannot accept any responsibility for any loss or damage howsoever caused as a result of using the software. Users are advised that all results from the software are checked by a competent person in accordance with good quality control procedures.

The software described in this document is furnished under a license agreement and may be used only in accordance with the terms of such license.

Copyright © 2010 – Delcam plc. All rights reserved

UK Training Centre
Tel: 0121 683 1050
Fax 0121 7665511

UK Customer Support
Tel: 0121 683 1010
Fax: 0121 7665542

ArtCAM Insignia 2010 Contents

Chapters	Page Number
<u>1. Introduction</u>	<u>1.1 – 1.16</u>
<u>2. Generating Vectors</u>	<u>2.1 – 2.18</u>
<u>3. Vector Editing and Layers</u>	<u>3.1 – 3.20</u>
<u>4. Bitmaps</u>	<u>4.1 – 4.6</u>
<u>5. Toolpath Options</u>	<u>5.1 – 5.2</u>
<u>6. 2D Vector Machining</u>	<u>6.1 – 6.16</u>
<u>7. 3D machining</u>	<u>7.1 – 7.16</u>
<u>8. Post Processing Toolpaths</u>	<u>8.1 – 8.8</u>
<u>9. Engraving</u>	<u>9.1 – 9.6</u>
<u>10. Drilling</u>	<u>10.1 – 10.4</u>
<u>11. Toolpath Templates</u>	<u>11.1 – 11.4</u>
<u>12. Machining Inlays</u>	<u>12.1 – 12.4</u>
<u>13. Nesting Vectors</u>	<u>13.1 – 13.4</u>
<u>14. Multiple Plates</u>	<u>14.1 – 14.6</u>

1. Introduction

Introduction

ArtCAM Insignia allows complex **2D and 3D products** to be machined quickly and easily from **2D vectors (ArtCAM Wireframe)** or **bitmaps (Image files)**. These **vectors** and **bitmaps** can be generated within **ArtCAM** or imported from other systems. **ArtCAM** can also import **3D Surface** data, which is translated on entry or after as a **Relief (3D)** model.

ArtCAM Insignia contains tools for creating and editing vectors from which toolpaths can be generated. Multiple toolpaths are easily generated for roughing, finishing and engraving. The toolpaths can then be simulated to allow complete visualisation of the product before actual machining.

Starting ArtCAM Insignia



- Double click the **ArtCAM** icon on the desktop screen with the **left mouse button**.

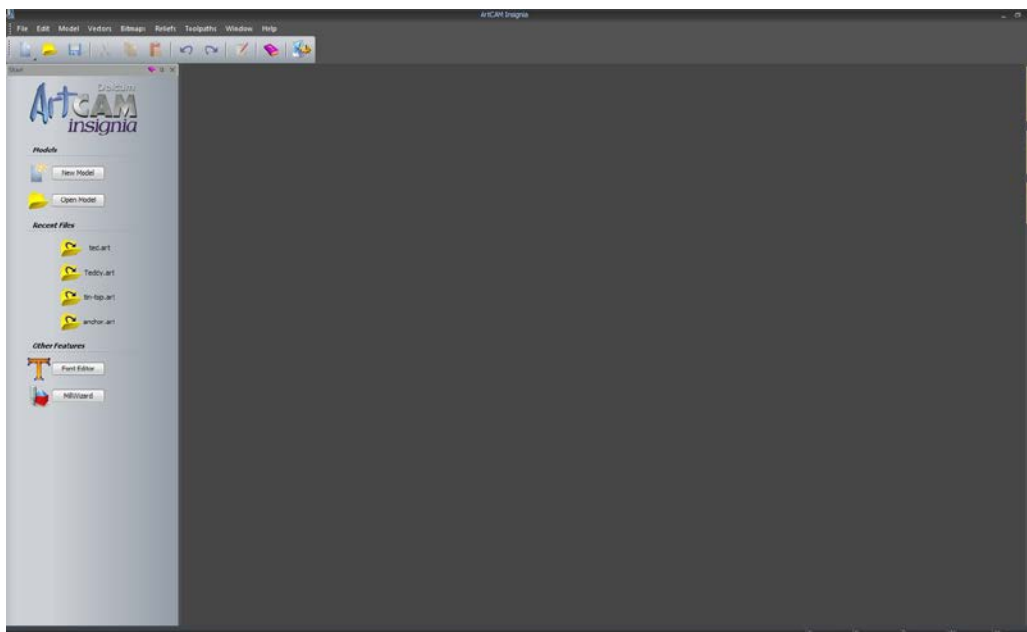

The **ArtCAM** start up screen appears as shown above. To start working in **ArtCAM** the user must create a **New Model**.

- Select **Create New Model**.

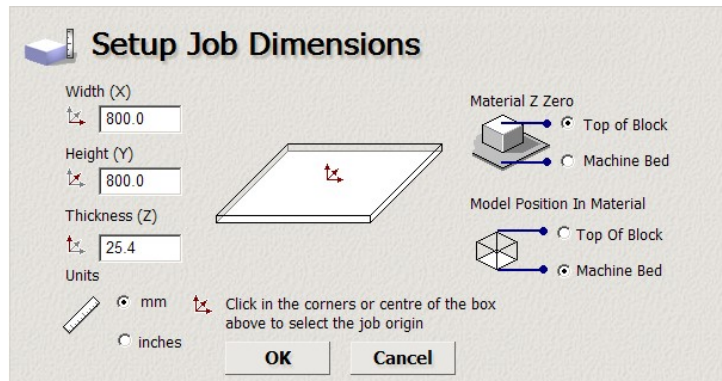
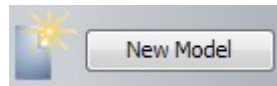

A **New Model** must have the following defined.

- The **X (Width)**, **Y (Height)** and **Thickness (Z)** according to the physical size of the model that is required.
- An **Origin** (datum) position. Click on model sheet to select position.
- **Material Z zero.**
Select **Top of Block** to position the cutting tool on the **Material surface**.
Select **Machine Bed** to position cutting tool on the **Bed of the machine**.
- **Model Position in Material**
Select **Top of Block** to align the zero plane of the model with the material surface.
Select **Machine Bed** to align the zero plane of the model with the machine bed.
- Set the **Height and Width** as **100** and **Thickness** as **20**
- **Set the units** as **mm** and select the **origin in the centre**.
- Set **Material Z Zero** at **Top of Block** and **Model Position** on the **Machine bed**.

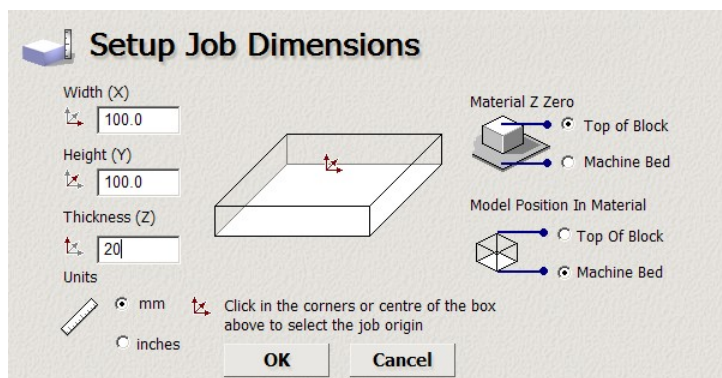

- Select **OK**.

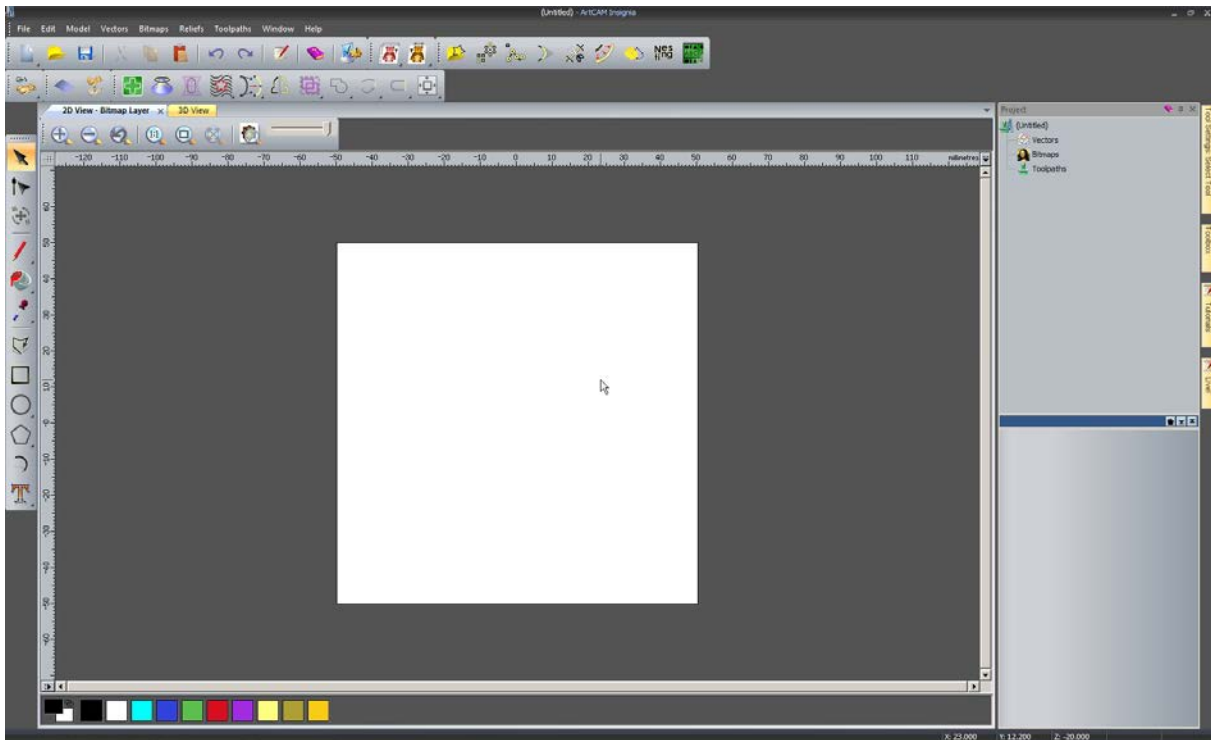

ArtCAM opens up displaying the **2D view**, with any **Relief and Toolpaths** displayed in the **3D View**. You can toggle the views by selecting **2D View - Bitmap Layer** (or **F2** or **F3** shortcut key).

The **2D view** is traditionally used for designing **vectors** (2D artwork) and **bitmaps** (images). Imported **Reliefs** (3D models), **Toolpaths** and **Simulations** can be viewed in 3D.

The following pages will summarise the key areas and available functionality within the **default** 2D and 3D environments.

ArtCAM commands are accessed from the **drop down Menu Bar** options or directly from their respective **Toolbars**.

2D View Summary.

The following summarises the **key** 2D view area and functions (default settings).

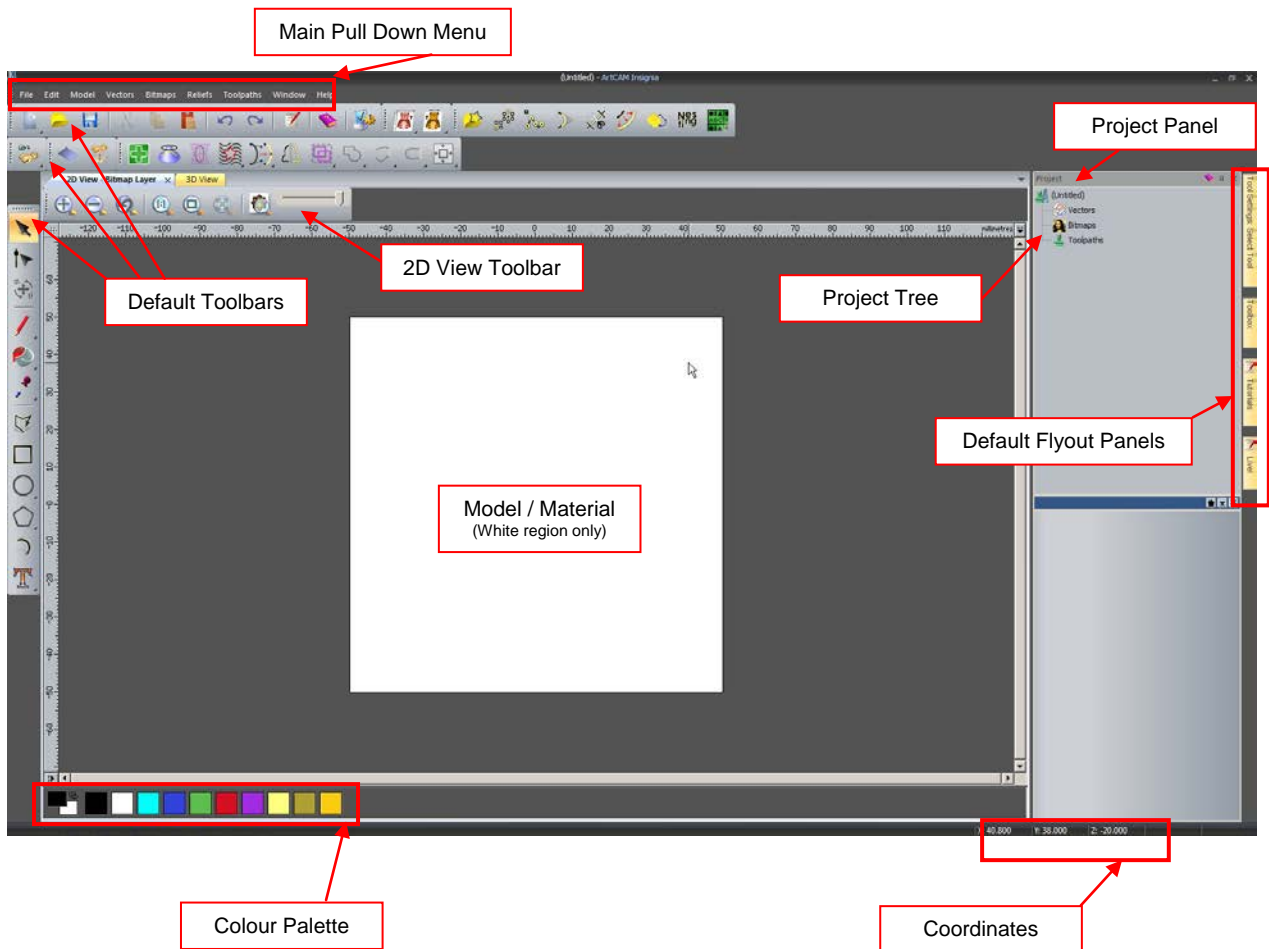

Zoom In > Zoom in the 2D view.



Zoom Out > Zoom out the 2D view.



Zoom Previous > Zoom to the previous view.



Zoom 1:1 > Zoom to 1 image pixel = 1 screen pixel.



Window Fit > Fit the artwork in the view.



Zoom objects > Zoom to fit the selected object(s).



Preview Relief layer > Show a colour preview of 3D Relief in the 2D view.



Bitmap Transparency > Adjust transparency of Bitmap in the 2D view.

3D View Summary.

The following summarises the key 3D view area and functions (default settings).

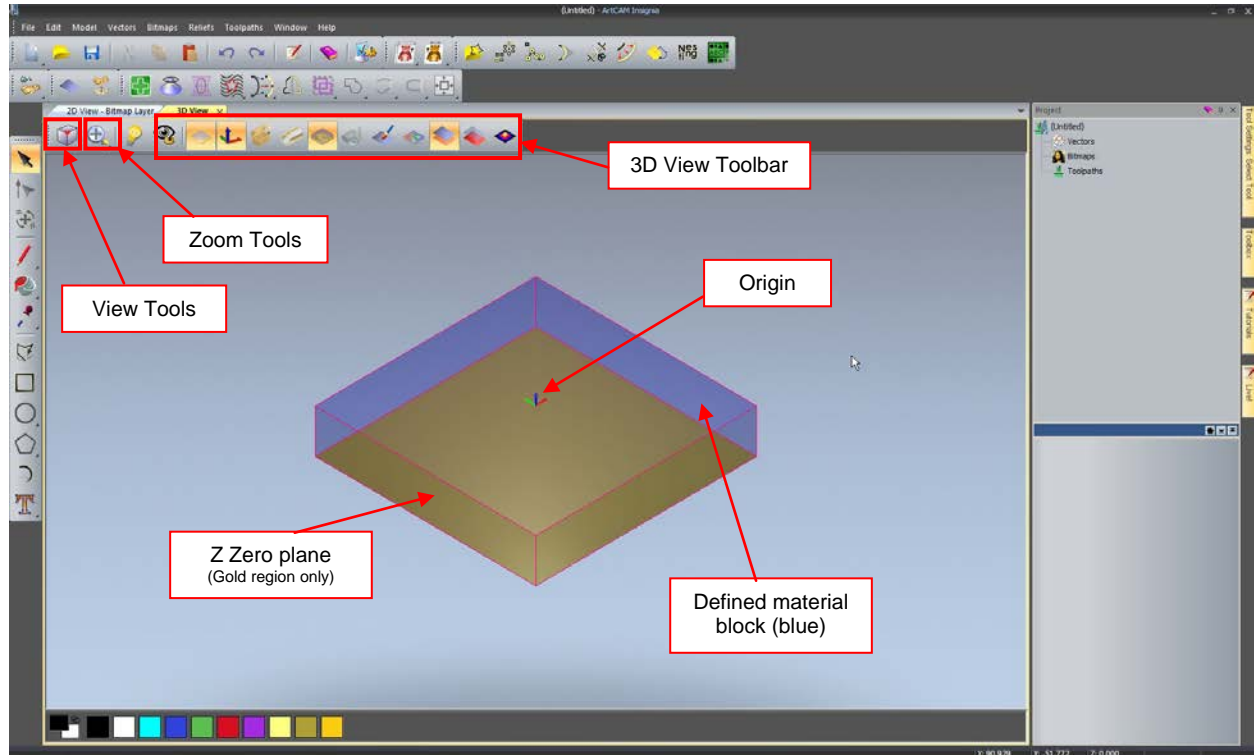

Isometric View.



View along the X axis.



View along the Y axis.



View along the Z axis.



Zoom In.



Zoom Out.



Zoom to previous view.



Scale view to fit.



Objects to draw (view) dialogue box.



Control various 3D graphics options.



Toggle Z zero plane.



Toggle drawing of the origin.



Toggle visibility of root assembly (in project)



Toggles between displaying flat and rotary reliefs.



Toggles visibility of the defined material block.



Toggles visibility of the simulation block (from machining).



Toggles colour shading (bitmap)



Toggle display of the front relief.



Toggle display of the back relief.



Toggle relief gradient analysis tool.

Main Menu Bar

At the top of the **Main window**, there is a **Pull Down Menu Bar**.

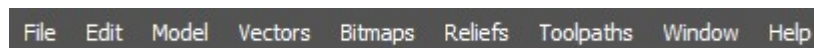

Clicking on a menu item opens a pull-down menu that contains submenus and commands. If a menu item **does not apply** to the currently active view it will be **greyed out**.

Sub menus are indicated and selected via the arrow  at the right hand side (where applicable).

For example, the **File menu** expands to show the following.

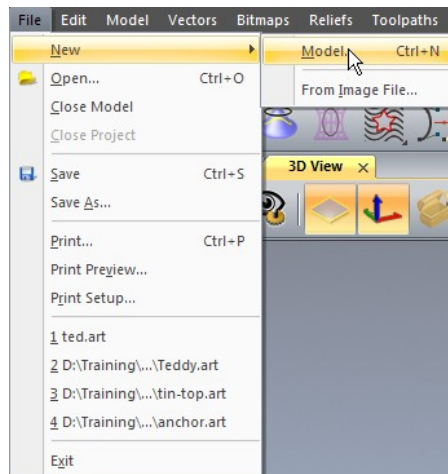

A yellow bar highlights the function over which the mouse cursor passes. Left mouse button then activates the function.

On certain commands, the keyboard shortcut is listed next to the description. For example, the shortcut to create a new model would be to press the **CTRL** key and then the letter **N**.

Toolbars

The **default toolbars** are summarised below.

The **left hand side** of the ArtCAM interface is occupied by a Toolbar. This is the **Design Tools** Toolbar and contains four key design areas.



Selection Tools

This section contains tools that **change the vector** mode, such as the default **select** function, the **Node Editing** and the **Transform** function.

Bitmap Tools

This section contains the most common tools for painting and working with colours. Items such as paint brush, flood fill and pick colours are located here.

Vector Tools

This section contains all the main vector drawing tools. Available are the creation of Polylines, Squares, circles, ellipses, stars, polygons, arcs and text.

File Toolbar



Contains the standard **Windows functionality** including the **Help reference** and **Options settings**.



New Model/New Project > Creates a new blank ArtCAM Model or Project (flyout).



Open > Open an existing ArtCAM file or image (.art, .bmp, .tif, .gif, .jpg, .rlf (relief)).



Save > Save the current ArtCAM model or Project.



Cut > Move the currently selected object to the clipboard.



Copy > Copy the currently selected object to the clipboard.



Paste > Paste the currently selected object into the model.



Undo > Undo the last command



Redo > Redo the last Undo command



ArtCAM Notes > Add written notes to the current ArtCAM file.



Help > Launch ArtCAM's online help.



Options > Change global settings for ArtCAM.

Model Toolbar

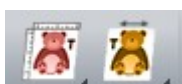

Includes tools to **modify** the **Model size, resolution, Origin, Position** and **Lighting (shading)**.

Vector Creation



Advanced creation tools for vectors including **Offset**, **Bitmap to vector** and **Nesting**.

Relief Creation



Tool to **Paste a Relief** into the current layer.

Relief Editing



Tools to **Reset** and **Scale** the imported Relief.

Vector Editing



Tools to edit current vectors such as **Vector doctor**, **Wrap vectors**, **Clipping**, and **Mirroring**.

Flyout menus



Several icons have a **small arrow** located at the **bottom right hand corner**. This indicates that this icon has further hidden functions which can be accessed from a flyout.

Select and hold the left mouse button over an icon (with the arrow) will reveal the functions in the flyout menu. Releasing the mouse over the desired function will activate it.

For example selecting the **Circle icon** from the **Design Tools Toolbar** reveals the ellipse.

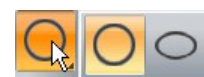

Selecting Draw reveals the Paint and Paint selective functions.



Project Panel

The right hand side of the ArtCAM interface is occupied by the **Project Panel** and several **Flyout panels**.

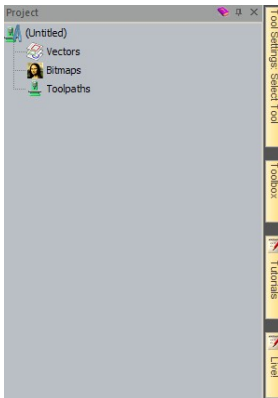

The **Project Panel** serves as a central area to manage the main design and machining aspects of the **ArtCAM model**.

When an item is highlighted, the lower half of the panel displays further information.

A summary is provided below.

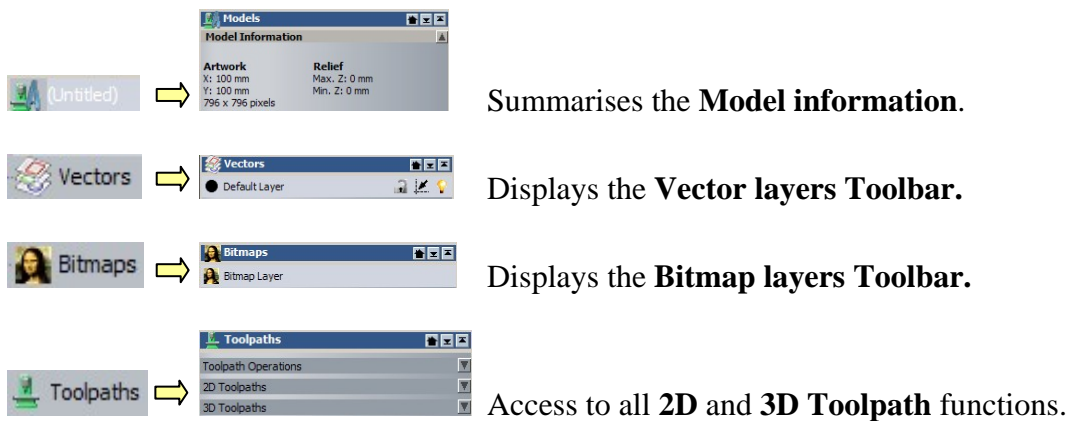

Right mouse selecting on an item in the Project Panel reveals the equivalent functionality (summarised above).

For example, Right mouse selecting the **Vectors** option reveals all the **Vector Layers functionality**.

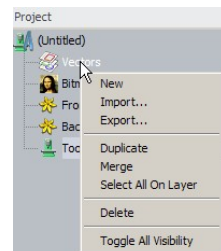

The functionality above will be discussed in greater detail throughout the training course.

Note: Although the **Project panel** provides a central area, all individual functionality shown above can also be accessed from either the **top Pull down menu**, or their **specific toolbars**.

Flyout Panels

The four default hidden panels on the **right hand side** can be activated by simply **holding the mouse cursor** over the desired flyout tab.



The **Tool Settings Panel** displays all the **settings and information** about the **current** or active function.

For example, If the **create circle** function  is selected, The Tool settings Tab will reveal the Circle Creation form where required sizes and coordinates can be entered. **Keyboard shortcut F6** also reveals this tab.

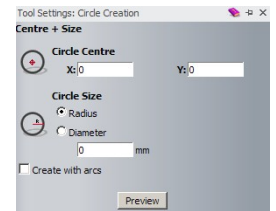

The **Toolbox Panel** reveals external **ArtCAM Plug ins** (applications) that have been created and are compatible with ArtCAM. For Example, the **Face Wizard** can be found here.

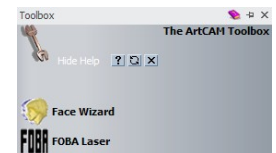

The **Tutorials panel** will provide a resource for Training materials and tutorials.

New to 2010, The **Live Panel** will provide access to an online database of **Training videos**. This area is subject to live updates and additional videos released by Delcam. **Note: Internet access** is required to obtain this resource.



Fly out Panels can be **fixed** (stay out) by selecting the **Pin icon**  at the **top right hand corner** of the panel.

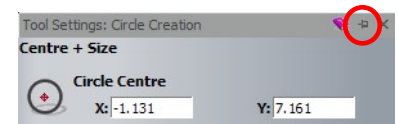

Reselecting the Pin will **hide** the panel. 

Selecting the **cross**  will **close and remove the panel tab** from the screen.

The following section will outline the ability of **ArtCAM 2010 to customise the interface** including **adding** and **removing** toolbars, **functions** and **Fly out panels**.

Interface customisation

Right mouse selecting in the **toolbars or grey border region** will present the following menu.

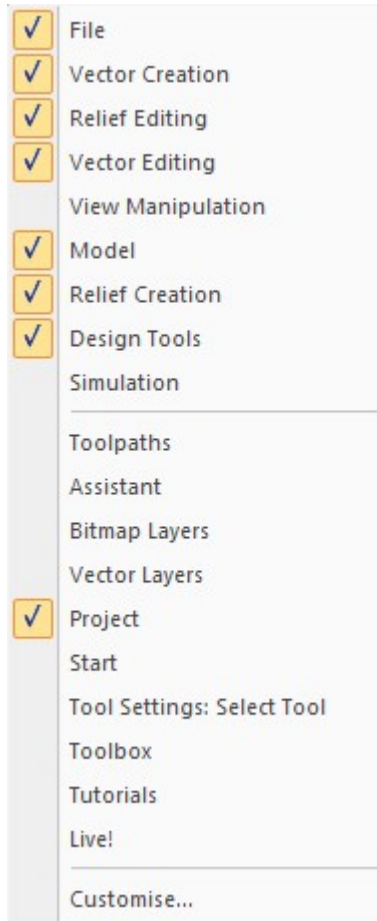

The **top half** of this menu lists all the **standard toolbars** available in ArtCAM. Items indicated by the **Tick**, , are currently **visible**. Selecting or unselecting the option will toggle its visibility from the interface.

The **lower half** of this menu lists all **standard Fly out Panels** available in ArtCAM.

As above, selecting/unselecting the will toggle its visibility.

If a **Panel was closed** previously, it can be reactivated here.

Selecting **Customise** will present a **new menu** which allows extensive customisation of the layout. This is outlined below.

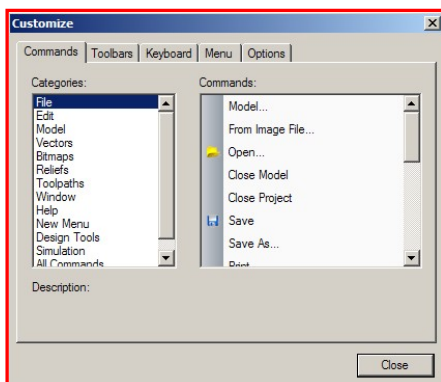

Commands All **Commands are listed** here. These can be **dragged and dropped** into existing visible toolbars.

Toolbars Toggles **Toolbar visibility** and ability to create a **new customised Toolbar**.

Keyboard **Keyboard shortcuts** can be assigned here.

Menu Options to **customise menu** including animation.

Options General Toolbar options including **Tool tips** and **icon size**.

Docking Toolbars

Toolbars can be **dragged** into the interface and allowed to 'float' in a desired location.

At the **end** or **top** of each toolbar there is a dotted line.



When the mouse cursor is placed over this line, it changes to a cross  at which point the toolbar can be selected and dragged.

Double Mouse clicking in the **top margin area** of the Toolbar returns it to the original fixed location.

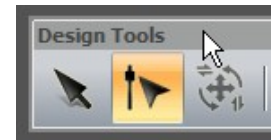

Docking Fly out Panels

When a **Fly out Panel** is **fixed**,  it also can be **dragged (to float)** or **docked in a fixed position** at each end of the screen.

Select and Hold the **mouse cursor** in the top margin to drag the Panel into the screen.



Whilst **dragging**, the interface displays a **cursor pad** in the **centre and edges of the page**. Depending on which arrow the panel is moved over, the screen will display a blue region where the panel will dock. Release the mouse button to dock the panel in this location.

Panels can also be docked onto the top or bottom half of other fixed Panels. This is achieved by dragging a panel (as described above) onto another Panel to activate the 'cursor pad'.

Themes and Layout

From the top **Window**  **drop down menu**, a number of interface options are available.

From **Window > Theme.....**

Select **Classic** to change the colour scheme from the **current 2010** theme a traditional ArtCAM background.



From **Window > Reset Layout.....**

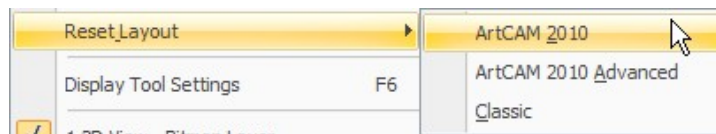

Select **ArtCAM 2010** to quickly **reset** the interface to **default settings**.

Select **ArtCAM 2010 Advanced** to change the interface to an **advanced setting** where all toolbars are switched off.

Select **Classic** to change the interface back to **ArtCAM 2009**.

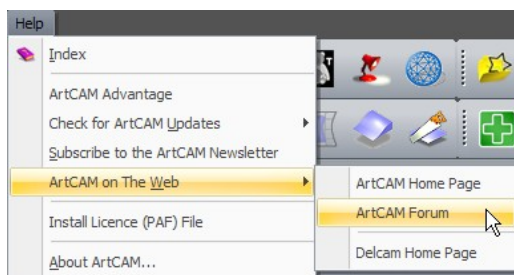

ArtCAM Help

By selecting **Help > Index** from the top Menu bar (or by pressing the F1 shortcut key) a Help Page will open over the graphics area.



Further sources of information and help can be obtained from the **ArtCAM website** and dedicated **Forum**.

Individual function forms can be expanded to provide a detailed explanation of each available option/entry.

This is achieved by selecting the **Help icon**  in the top right hand corner of the active form. The example below applies to the **Rectangle creation** function. 

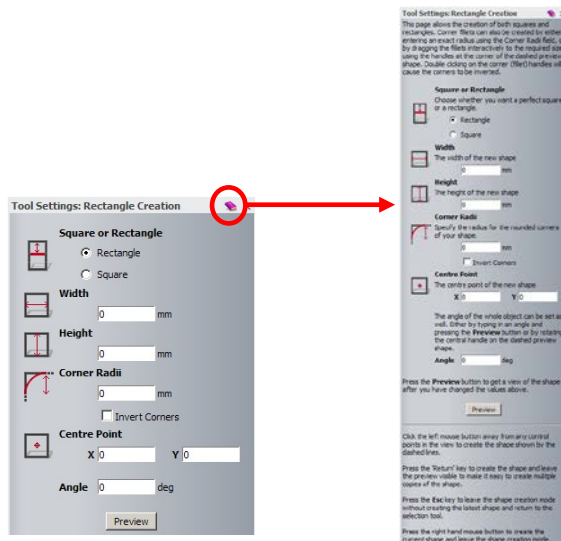

ArtCAM File structure

ArtCAM Models (*.art)

An **ArtCAM Model** will contain all entities created within the session such as **Bitmaps** (image files), **Vectors** (2D geometry) **Reliefs** (3D models) and **Machining data** (Toolpaths). This ArtCAM file is identifiable by having an **.art** extension and can be saved or exported as a whole.

It is also possible to Import and save/export independent entity types from within the **ArtCAM Model**. These include the **Vectors** (mainly **.eps .dxf .dgn .pic** formats), **Bitmaps** (**.bmp, .gif, .jpeg**), and **Machining Output** (**.tap**).

For more advanced applications where it is required to create an assembled group of separate **Relief models** (**.rlf**), an **ArtCAM Project** is first opened in which several **ArtCAM Models** can be created and combined as required for an assembled item. When saved, the **Artcam Project** is identifiable by a **.3dp** extension. To enable the **Reliefs** to co-exist together, the individual components are converted within the **Assembly** as **Triangle Mesh** models. ArtCAM can also **import surface models** (e.g. **iges**) directly into an assembly.

Design

Vectors (2D artwork) and **bitmaps** (images) can be generated within ArtCAM or imported from other systems. **ArtCAM** can generate reliefs from an imported model. When dealing with bitmaps and Reliefs it is important to understanding **Resolution**, which will influence the overall surface detail of the relief and ultimately the final piece.

Manufacture

The final stage for most **ArtCAM models** is to manufacture the design as a real object. **ArtCAM** can calculate the **toolpaths** required to machine the **vectors directly** or **relief**. The calculated toolpaths can be then sent directly to the machine (via post-processing) ready for cutting.

Mouse buttons application

Each of the **three mouse buttons** performs a different operation in **ArtCAM Pro 3D View (F3)**. By using the **ALT, Ctrl** or **Shift** key on your keyboard, these operations can be extended as the following details explain.

Left mouse button: Picking and selecting



This button is used for selecting items off the **main pull down** menus, inputting data and selecting parts of the model.

Middle mouse button or wheel: Dynamics



Zooming:

Scroll the **middle mouse** to Zoom IN/OUT of the model. This applies to the 2D and 3D view. Alternatively, Select the **SPACE BAR** and **Right mouse button** together and move the mouse to Zoom IN/OUT. (This option applies to the 3D view only)

Panning:

Hold down the **Left and Right mouse buttons** and move the mouse, to move the view across the component.

Rotating/Twiddle:

Hold down the **middle button/wheel** and move the mouse. Alternatively Select the **SPACE BAR** and **Left mouse button** together and move the mouse. (This option applies to the 3D view only)

2. Generating Vectors

Overview

Vectors are mathematically defined shapes consisting of a series of points (nodes), which are connected by lines, arcs or curves (spans) to form the overall shape.

They can be:

- Generated directly within **ArtCAM** by using the **Vector Tools** in the **Assistant** page;
- **Rectangles, Squares, Circles, Polylines, Ellipses, Polygons, Stars** or **Text** that can be edited if necessary to generate the final **vectors** to create a **Relief** from;
- **Imported** from another drawing package, using the **File – Import** menu option, or copied and pasted from another package using the standard **Windows** commands.

Mobile Phone Cover Exercise

In the following exercise you will generate a **Mobile Phone Cover** using the **Vector Tools**. Below is a drawing of the item including basic dimensions, so that you can get an idea of how the final product should look before working through the 'step by step' instructions.

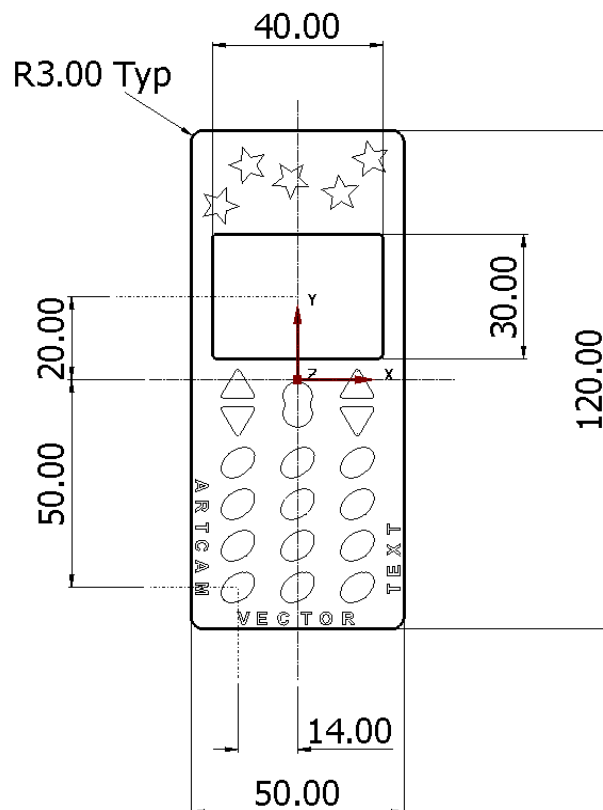

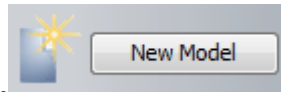

- Select **New Model**.
- Enter a **Height** of **150mm**, a **Width** of **80mm** and a **Thickness** of **15mm**.
- Set the **Origin** to the **centre** and both **Z Zero** and **Model Position** at the **Top Of Block**.

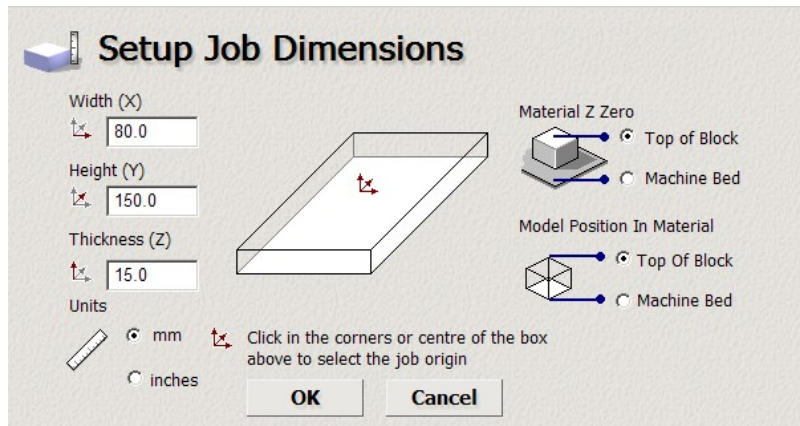

- A **new ArtCAM Model** (sheet) is generated based on the parameters defined above.

The vector creation tools (any many others) can be accessed in a number of ways.

1. The default **Design Tools toolbar** on the left hand side.



2. Activate the **Assistant Tab** by **right mouse selecting** in the **grey border**.

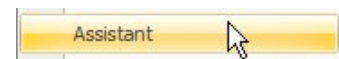

3. **Right mouse select** in the white model sheet and select the **Drawing** options.

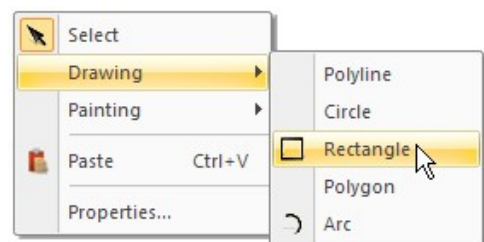

- Using a method outlined above, Select **Create Rectangle**. 
- The **Rectangle creation** form appears in the **Tool settings** form.

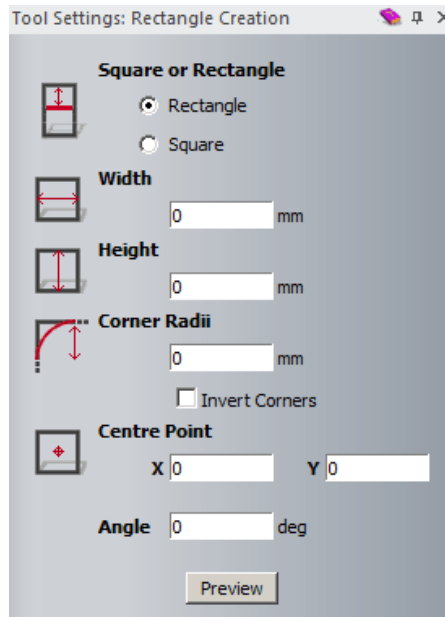

- Enter a **Width of 50mm**, a **Height of 120mm**, **Corner Radii of 3mm** and a **Centre Point of X 0 and Y 0**.
- Select **Preview** to view the proposed shape (represented as dashed lines)

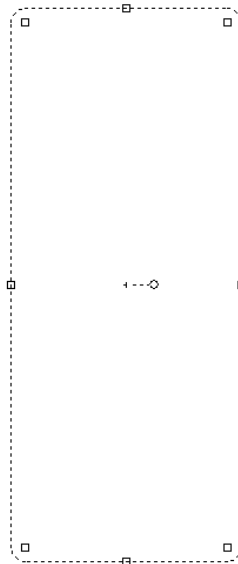

- To **create the shape**, **single left mouse click** in the view area.

The rectangle is created on the model page whilst keeping the rectangular creation form open. This can be utilised to create a new rectangular shape.

Note: A single right-mouse click would create the shape, but close the vector creation form.

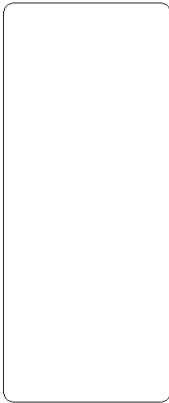

The outer **shape** of the phone **cover** is created.

- In the Rectangle Creation form, change the **Width to 40mm, Height to 30mm, Corner Radii to 1mm** and the **Centre Point to X0 and Y20**.
- To create the shape, **single right mouse click** in the view area (and close the form)

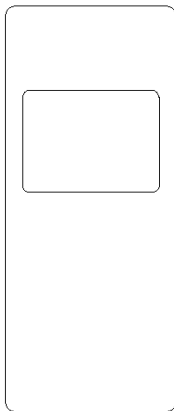

This second **Rectangle** will represent the display window.

- Select **Create Ellipse**. 
- Enter a Start Point of **X -14 Y -50** with a **Height of 7mm, Width of 10mm** and an **Angle of 140 degrees**.

- **Right mouse click** to create the shape.

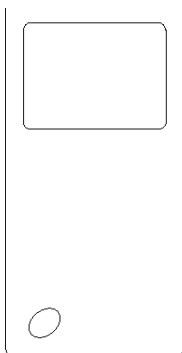

A **block pattern** of this single **Ellipse** can be created quickly to complete the keypad.

- With the **Ellipse** selected, click on the **Block Copy / Rotate**  icon from the **Vector Tools** area on the **Assistant's** page or top of the screen.

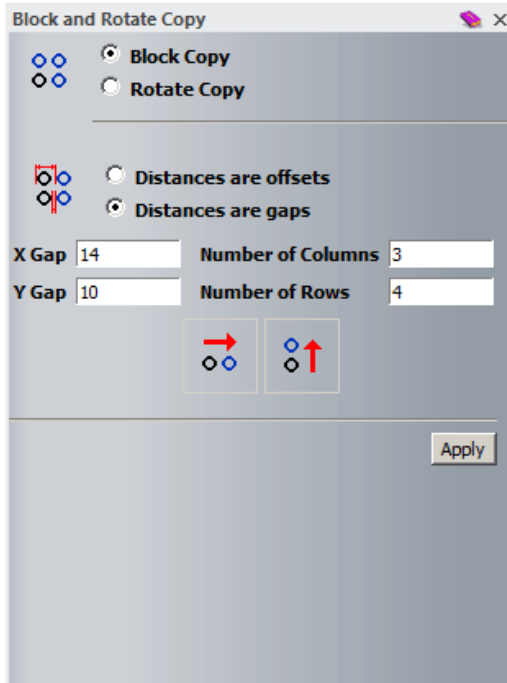

The **Block and Rotate Copy** allows you to create a **block copy** in **X** and **Y** or a **rotated copy** around a point.

The distances can be set as an offset value or by a gap value between each item.

- Select **Block Copy** and **Distances are offsets** options.
- Select an **X Offset** of 14mm, with **Number of Columns** as 3.
- Select a **Y Offset** of 10mm, with **Number of Rows** as 4.
- Select **Apply**.

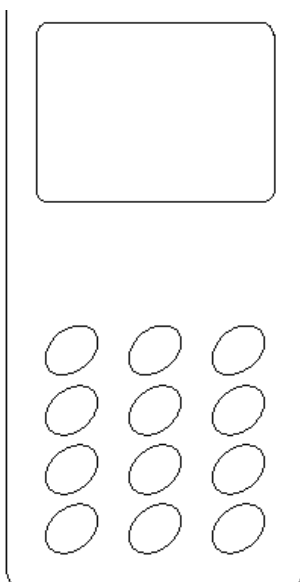

The keypad is created.

A centre 'menu' button will be created from two combined circles.

- Select **Create Circle**.

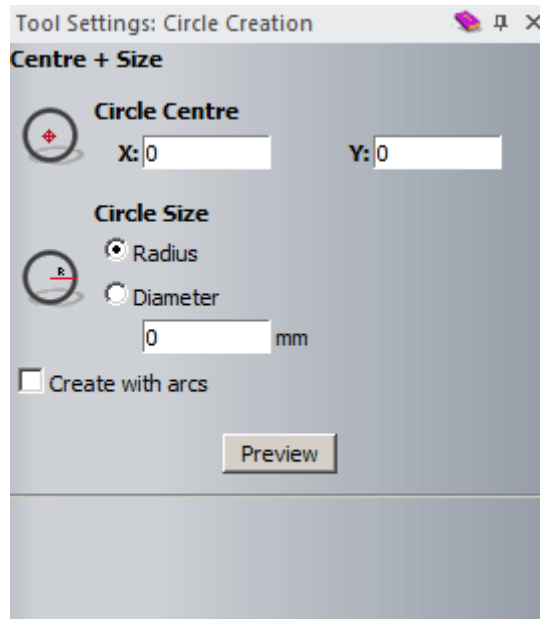

- Tick the option **Create with Arcs**.
- Create a circle with centre at **X0 Y-4**, **radius as 4mm**.
- Create a second circle or **radius 4mm** but with centre at **X0 Y-8**.

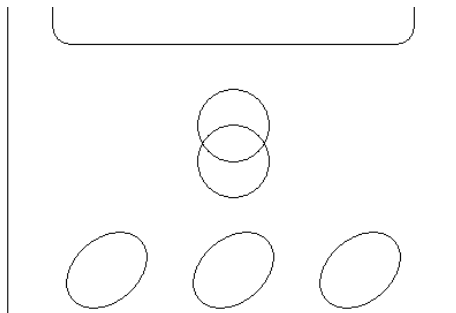

The **Circles** will now be 'merged' into one.

- Select **both circles** and select the **Weld** button  from the **Position, Combine, and Trim Vectors** area on the **Assistant's** page.

By **welding** the two **Circle** vectors, a new single vector is created.

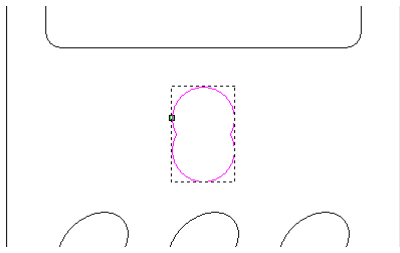

Note: The **Weld** command only works on two selected closed vectors.

- **Zoom in** to see the vector more clearly.

Zoom either using the  tool or middle mouse cursor.

- With the new vector selected, select Node Editing. 
- Hover the mouse over a **left black node**, press the **right mouse button** and from the side menu select **Smooth Point** (or press **S** on the keyboard).

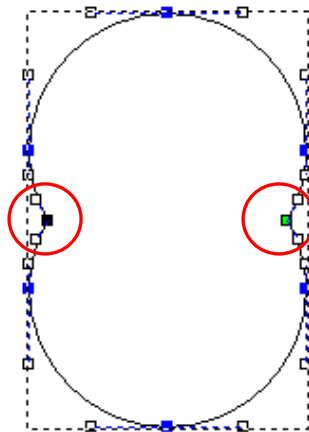

- Repeat for the other side to provide a shape with smooth inner corners.
- Press **N** to return to **Select** mode and click away from the vector.

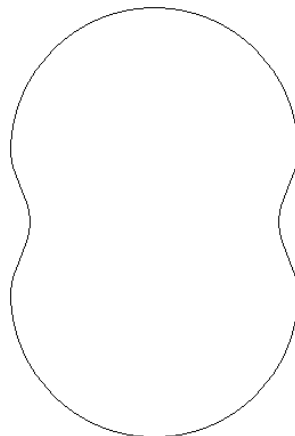



- Select **Create Polygon**.

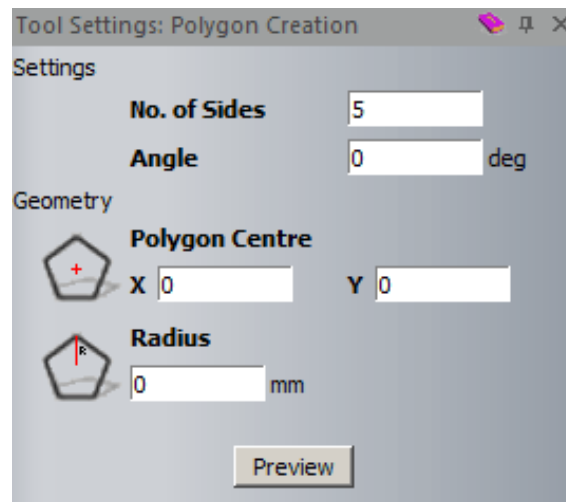

- Enter **No. of Sides** to be 3, **Angle 0**, **Polygon Centre** at X -14 , Y -2 with a **Radius** of 4mm.
- **Create** the triangle shape (left/right mouse click)

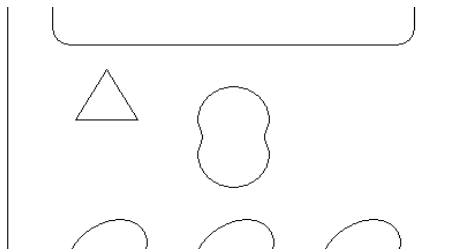

- With the Triangle vector selected, select **Offset Vector(s)**.



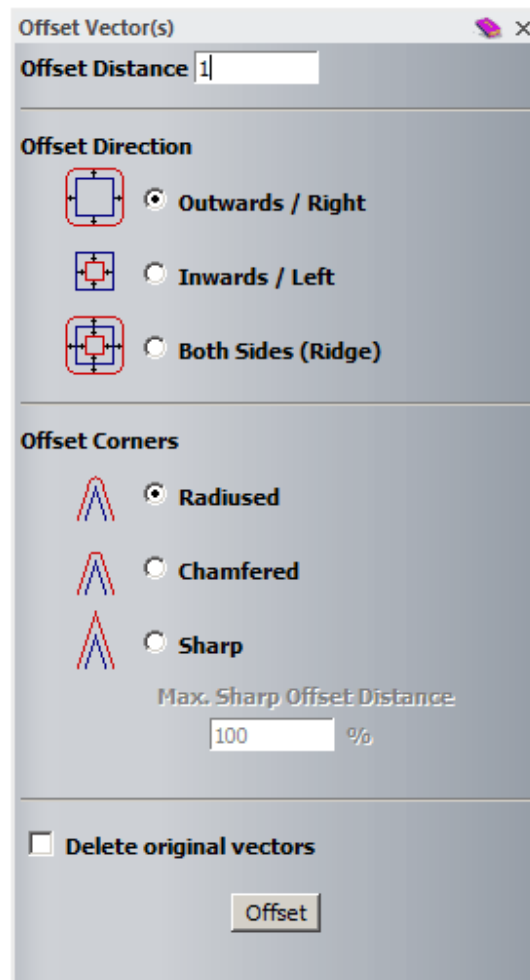

- Select an **Offset Distance** of 1mm, **Offset Direction** as **Outwards** and **Offset Corners** as **Radiused**.
- Select **Offset** to create the new shape.

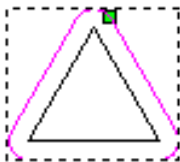

The new **vector** is **Radiused** at the corners.

- Select the **original inner vector** and press **Delete** on the keyboard.
- Select the **new vector** and select **Mirror Vectors**.



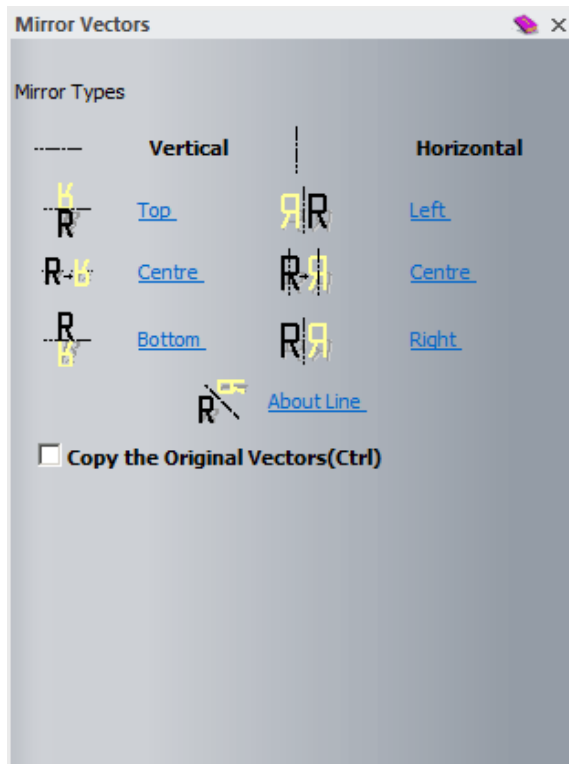

The **Mirror Vectors** page allows you to mirror the selected **vectors** about themselves or about a selected line.

Note: You must select the **mirror line** first before applying the **Mirror Vectors - About Line** option.

- Select **Copy the Original Vectors (Ctrl)**,
- Select **Bottom**  to create the mirrored triangle.

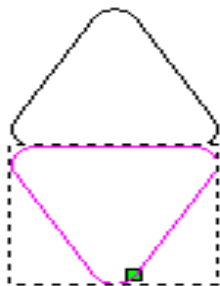

The **new vector** will be moved downwards. It can be nudged using the **down arrow** or moved more accurately by a value using the **Transform Vectors** command.



- Select **Transform Vectors** (or hit **T** twice on the keyboard).

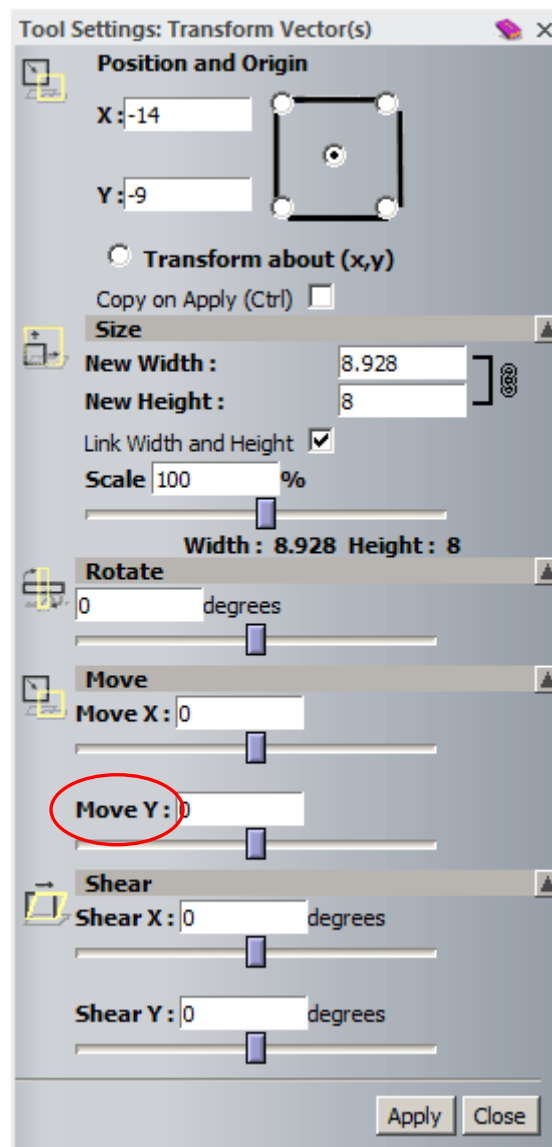

- Enter **Move Y** as **-1**, select **Apply**.
- Select both **Triangular vectors** and then select the **Group** button.

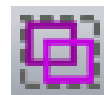

The two items can now be treated as one.

A **polyline** will be created to use as a mirror line for this grouped feature..

- Select Create Polyline.

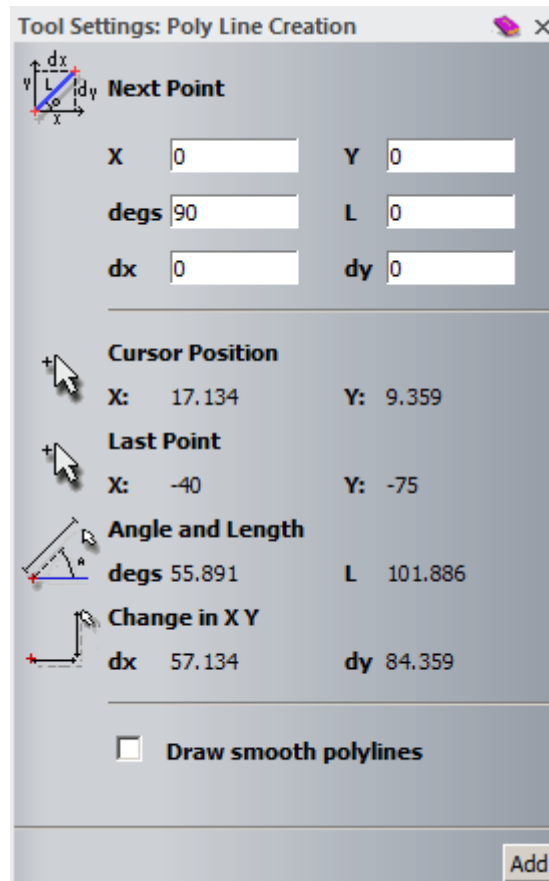

Polylines can be generated by entering **absolute co-ordinates** in the **X** and **Y** area, by angles and line length, as **relative co-ordinates** using the **dx** and **dy** (distance from last point) or by clicking with the cursor.

Note: **Polylines** can also be created dynamically in the graphics area either by holding down the left mouse key while freehand sketching a curve, or by using the left mouse key to click individual points along the required route.

- Select **Add** (enters a point at 0, 0).
- Enter **30** in **dy** (**30mm** in **Y** direction), select **Add** and then **Close**.

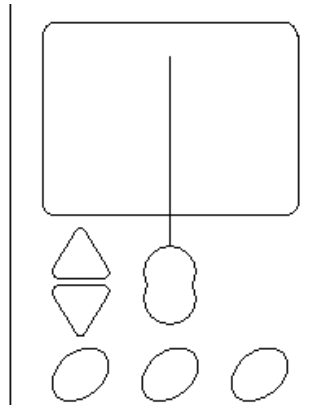

- Select the **Polyline** first and then **shift select** the **triangle group**.
- Select the **Mirror** button. 
- Select Copy the Original Vector option.
- Select **About Line** to create the mirrored feature.
- Delete the **Polyline**.

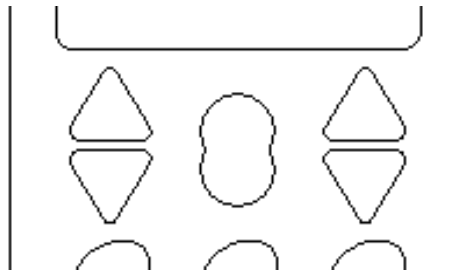

- Select Create Vector Text. 

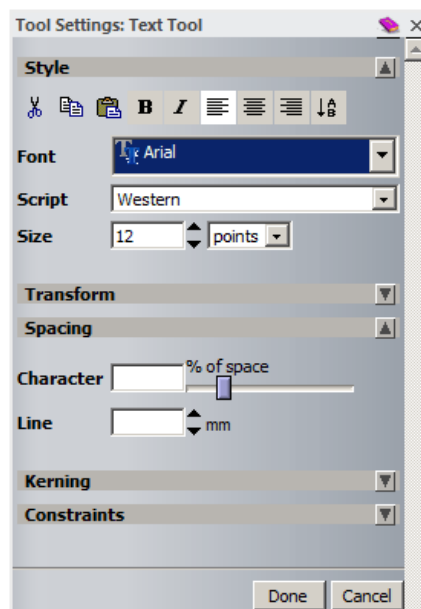

- Select Font as **Arial**, **Script** as **Western** and **Size** as **3mm**.
- Click at the bottom of the **2D View** and type **ARTCAM VECTOR TEXT**.
- Select **Done**.



ARTCAM VECTOR TEXT

This **Text** can be wrapped around the **outer vector**, with the text inside, using the **Wrap text round a curve** option.

- Select **Wrap text round a curve**.

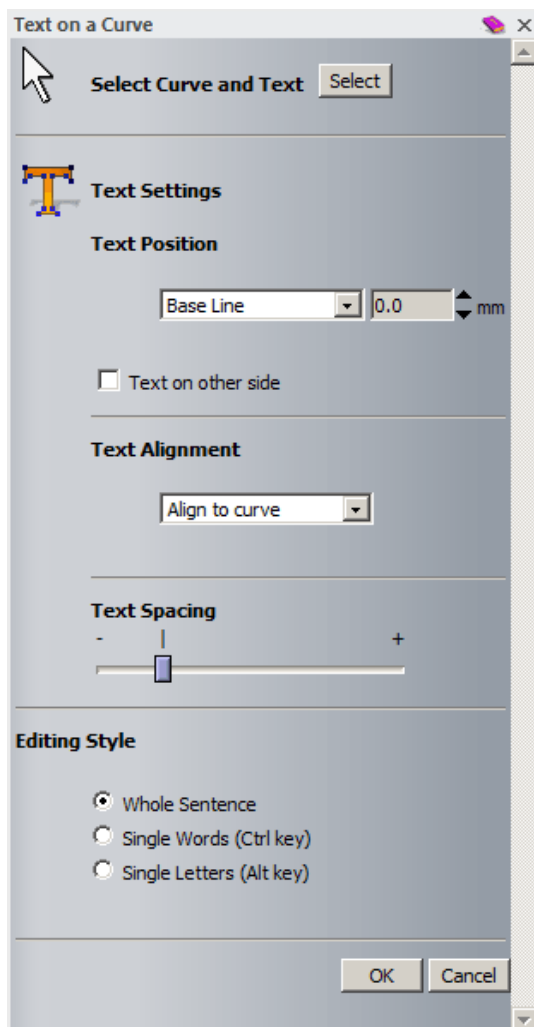

The **Text on a Curve** page appears, which allows you to align an existing **Text Vector** to a **Curve Vector**.

Text Position includes options that control the relative, position of the **text** across the curve.

Text on other side puts it on the other side of the curve.

Text Alignment includes options that control the flow of the **text** along the curve.

Text Spacing allows you to vary the spacing between the individual characters.

Editing Style allows you to set individual **Words** or **Letters** to be repositioned around the curve independently.

- Select the **Text** and shift select the **outer vector** and press **Select** in the **Text on a Curve** page.
- Select the **Text Position** option as **Specify** and enter **1mm**.
- Tick the option **Text on other side**. (if text is on the outside)
- Select the **Editing style** option as **Single Words**.
- **Dynamically Move** the **text** using the **cursor** to align on the **three sides** as shown below.
- Select **OK**

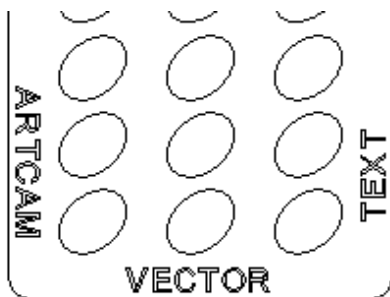

The **Text** is now **wrapped**.

- Select **Create Polyline**  and in the form select the option **Draw smooth polylines**.
- Left mouse click **5** suitably positioned **points** to create a **Smooth Polyline** similar to the one shown below.

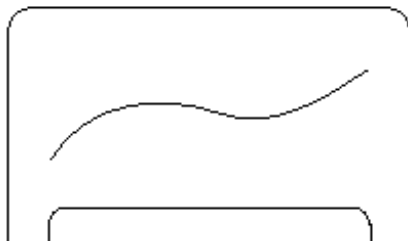

You will use this **Polyline** to **paste vectors along**.

- From the **Vector Tools** area, select **Create Stars**.

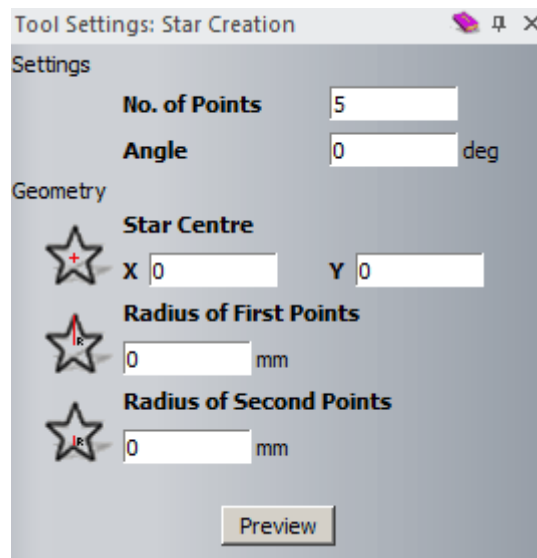

- Enter **No. of Points** as 5, **Star Centre** as X –28, Y 62, **Radius of first Points** as 4.5mm and **Radius of second Points** as 2mm.
- Preview** and **create** the star.
- Select the **Star** vector and **shift select** the sketched **Polyline**.

- From the Vector Tools area, select Paste along Curve.

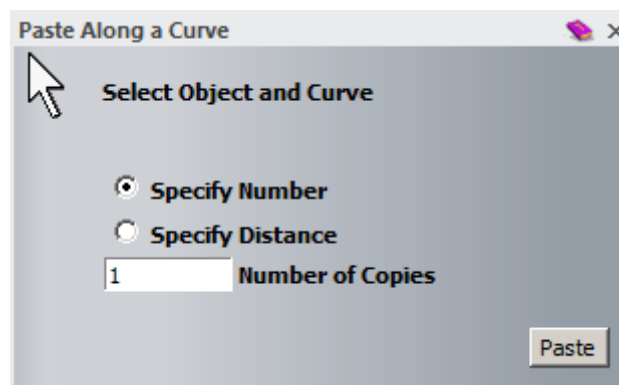

The **vector** is pasted incrementally along the curve either by dividing the curve equally (**Specify Number**), or by a fixed distance, leaving any surplus at the end of the curve (**Specify Distance**).

- Select **Specify Number** and enter Number of **Copies as 5**.
- Select **Paste**.
- Delete the original **Star** vector and the sketched **Polyline**.

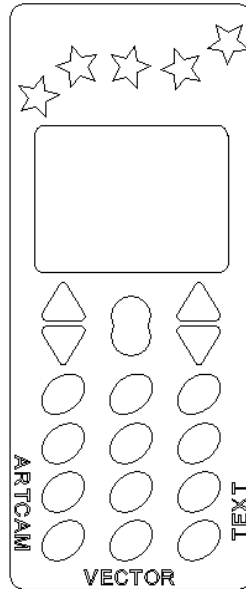

- Select **File - Save As**, browse:

D:\users\training\COURSEWORK \ArtCAMPro-Jobs and enter as File name - **training-phone-cover**.

- Select **File - Close Model**.

3. Vector Editing and Layers

Vector Editing

The following chapter will introduce several **Vector Editing** options.

Shield Design Exercise

- Create a **New Model** with a **Height of 20mm**, **Width of 20mm** and a **Thickness of 15mm**.
- Set the **Origin to the centre** and both **Z Zero** and **Model Position** at the **Top Of Block**.

Note:

You can also move the origin position by using the option **Set Model Position**.  This allows you to position the **zero datum** to the **Centre**, one of the **4 corners** or a typed **coordinate position**.

Vector input by snapping to a Grid

- From the top file menu, Select **Bitmaps – Views - Snap Grid - Snap Grid Settings...**

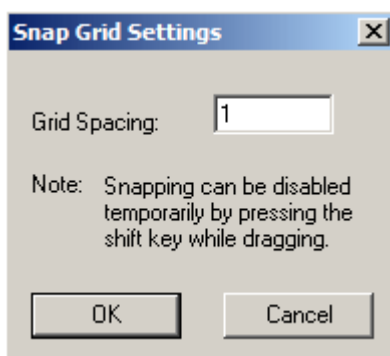

Grids provide **snap points** to assist in dynamically defining vector points. They are available from the **Bitmaps - Views** pulldown menu.

The selected grid spacing value is mainly dependent on the size and complexity of the component to be produced.

- Set the **Grid Spacing** to **1** and select **OK**.
- From the same top file menu, switch ON the options **Snap to Grid** and **Draw Snap Grid**.

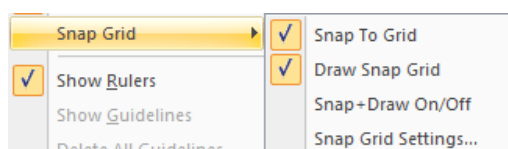

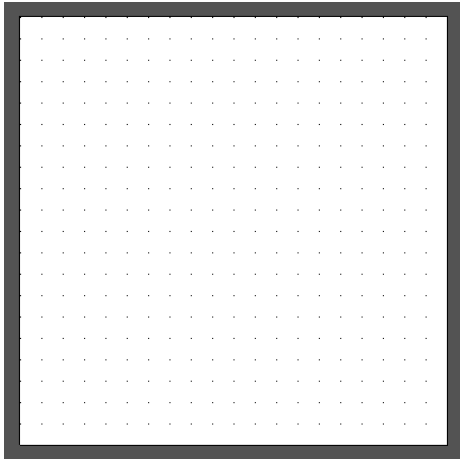

A grid is displayed in the view, with an even point spacing of 1mm.

- Select **Create Polyline**. 
- Snap to the same **Grid points** as shown in the image below.

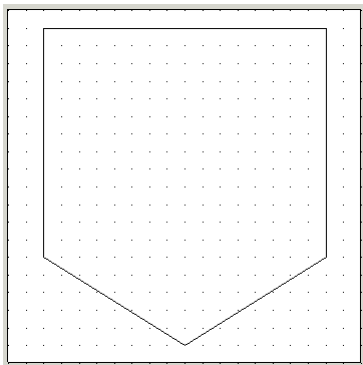

Note: The best position to **Snap** in a **vector point** is just to the lower, left of a **Grid point**.

- Select File - Save As:
D:\users\training\COURSEWORK\ArtCAMPro-Jobs\train-shield.
- Switch **OFF** both **Snap to Grid** and **Draw Snap Grid**.

- Select **Fillet vector with an arc**. 

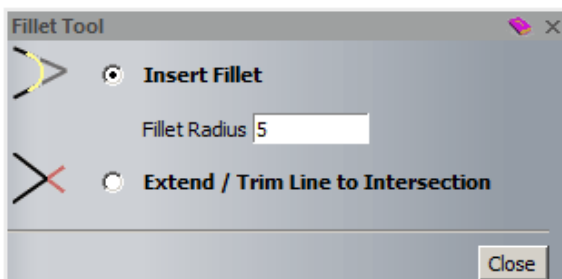

The **Fillet** is generated at a node point or from two **Polylines** that would intersect.

- Enter a **Fillet Radius** of **5mm** and select line **either side** of the **bottom point** to generate the fillet.
- Change the **Fillet Radius** to **1mm** and create a **Fillet** at the **top two corners**.
- Change the Fillet Radius to 2.5mm and create a Fillet at the bottom two corners.

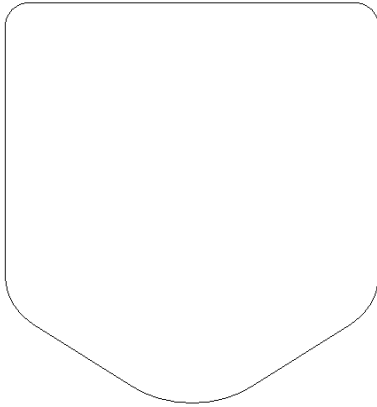

The main shield **vector** is as shown.

- **Close** the form.
- With the **vector** selected, select **Offset Vector**. 
- Set an **Offset Distance** of **0.5mm**, select **Inwards** and **Radiused**.
- Select **Offset**, followed by **Close**.

Vector input by snapping to Guidelines

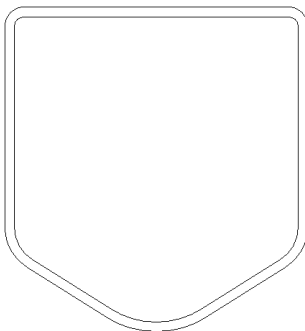

You've created a constant **Offset**. For the middle part, instead of using **Grid lines**, **Guidelines**, you will input actual values.

Guidelines are pulled from within the rulers located around the border of the model. For accurate positioning they can be snapped direct to **Grid points** or if the **Grid** is switched off once created they can be precisely positioned via a **Position Guide** form.

- Hold the **left mouse button** down within the **top ruler** (as shown) and drag down a horizontal **Guideline**.

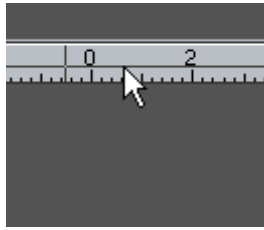

- Release the **left mouse button**, when it is **near to the centre** of the model.
- **Right mouse click** on the **Guideline** to activate the position guide.

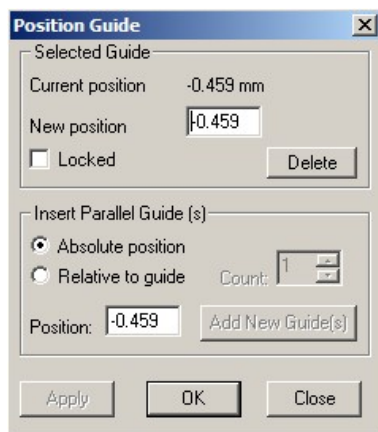

This form allows the guideline to be accurately positioned, deleted or further guides to be inserted.

- Enter a **New Position of 0** and select **Apply**.
- Repeat the process to generate a **vertical Guideline at 0** (by dragging it from within the **left ruler**.)

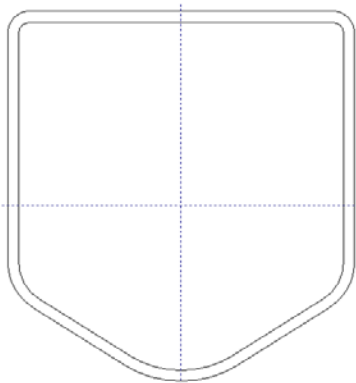

The two guidelines **intersect** at the origin. These guidelines can be snapped to, when creating or moving vectors or nodes.

You can show or hide these Guidelines by clicking on the Guidelines icon in the top left corner of the rulers.



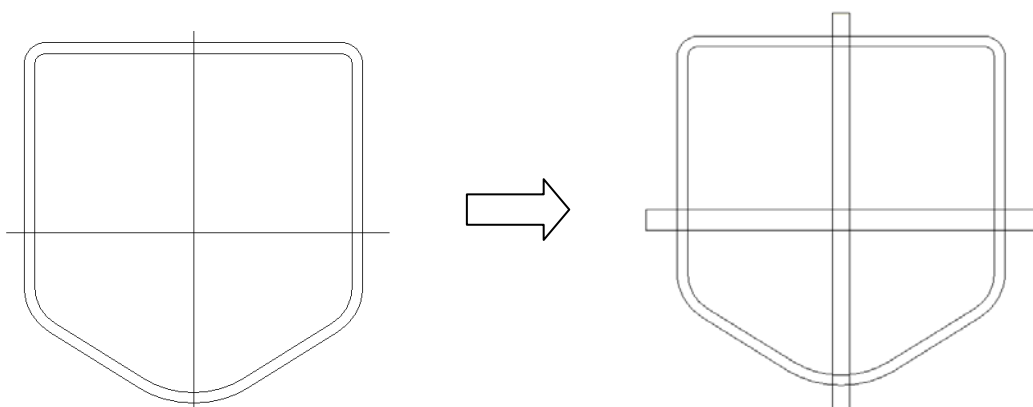

- Select **Create Polyline**.
- Snap on the Guidelines to create horizontal and vertical centrelines.

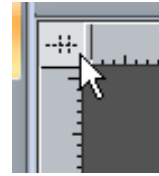

- Pick the top left corner icon in the 2D View to **switch off** Show Guidelines.



The **two new Polylines** will be used to create **Offset Copies** by setting the on **Both Sides (Ridge)** option.

- Offset  the horizontal Line vector **both sides by 0.5mm** selecting the **Both Sides (Ridge)** option.
- Offset  the vertical Line vector **both sides by 0.4mm**.
- Delete the **original Polylines** (if the **Delete original vectors** option was not set during the offset operations).
- Select **Trim vector to intersections**  and trim the **Polylines** to fit within the shield.

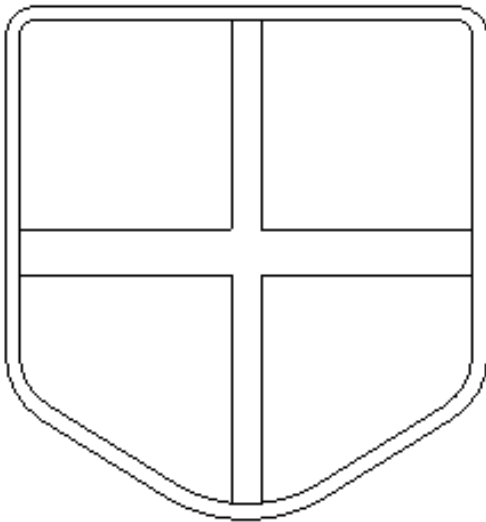

The completed **vectors** for the shield design are as shown.

- Select **File - Close Model** (do not save)

Vector Layers

Vector Layers provide a more ordered method of managing the **selection** and **display** of selected groups of **vectors**. In default mode **ArtCAM Pro** assigns all **vectors** produced to a layer named **Default Layer** (which cannot be **renamed** or **deleted**). Any additional **Vector Layers** can be **Renamed**, **Deleted** and **Merged** together. As new **Layers** are created specific **group of vectors** are assigned to them as required. The layers Tab also allows the user to **Open (Import)** and **Save (Export)** vector data.

The **Vector Layer Toolbar** can be **activated** by right mouse selecting in the **Grey border** (Right hand side) and selecting **Vector layers**.

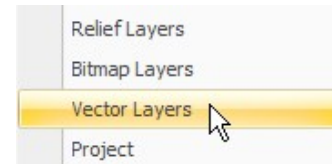

Vector Layers are controlled by this toolbar. The **default layer** is **highlighted** and any generated or imported vectors will be displayed, providing the layer is switched on (light bulb).

Phone Cover Exercise

- Open the model **training-phone-cover. art** from <D:\users\training\COURSEWORK\ArtCAMPro-Jobs>.

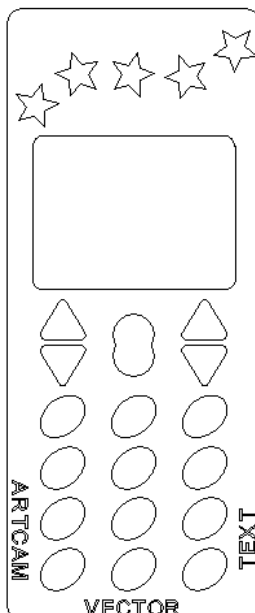

This exercise will show how to **import** vectors and also **move** or transfer existing vector data to other layers.

- Select the **stars vector** group.



Layers need to be generated before vectors can be placed into them. It is good practise to give the layer a sensible name.

- Select **New**  on the **Vector Layers toolbar**.

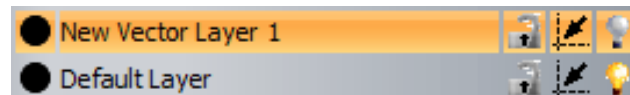

New Vector Layer 1 has been created. By double-clicking on the name itself, the name can be changed.

- **Double click** on **New Vector Layer 1**, overwrite as **stars** and select **Enter** (or mouse click away from the name) to confirm.



The **new level** is now named and switched on (denoted by the light bulb icon). 

- **Right mouse click** on the selected **star vector** group and select **Move Vectors To... > stars**.
- Switch off the **Layer stars** by clicking the **light bulb**.

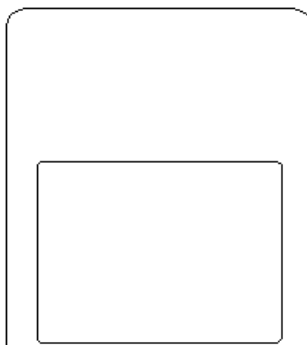

The **star vectors** are now **hidden**. The other vectors on the default level are still displayed.

Note: When a **Layer** is current (highlighted in colour) any vectors that are pasted are automatically placed on that layer.

- Create a **new Layer** and change the name to **buttons**.
- Create a **new Layer** and change the name to **holes**.



- Select the 12 Ellipse vectors.

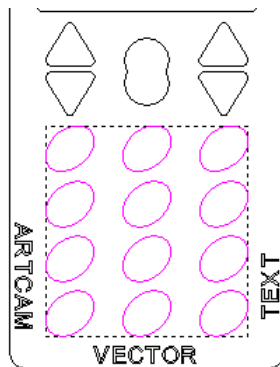



The **selected vectors** will be transferred to another **Layer**.

Note: **Layers** can have the snapping facility  switched on or off. For example if you had vectors close together and wanted to be sure you snapped to the correct vector on a layers, then you would switch snap off for all the other layers.

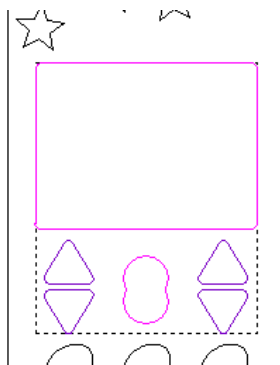
- **Right mouse click** on the selected **button vector group** and select **Move Vectors to.....> buttons**.
- Select the **other shaped vectors** as shown.





These selected vectors will be placed on another **Layer**.

Note: **Layers** can be locked,  so any vectors on that layer cannot be moved or edited until the layer is unlocked. 

- Right mouse click on the selected vector group and pick **Move Vectors to..... > holes**.



- Switch **off** the **Default Layer**,  leaving **on** the layers **buttons** and **holes**. 

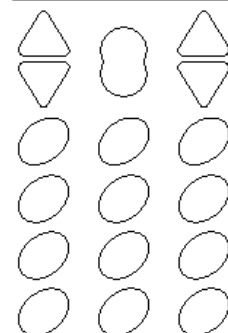



The vectors displayed are going to be combined into the one current layer **Merged Layer 1**.

- Select **Merge Visible**. 

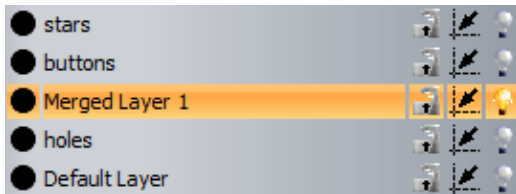



A new **Layer** called **Merged Layer 1** has been created with the visible data combined. The vectors on the layers can be coloured for identification.

- Select the **black circle**  to the **left** of the **Layer** name **Merged Layer 1**.

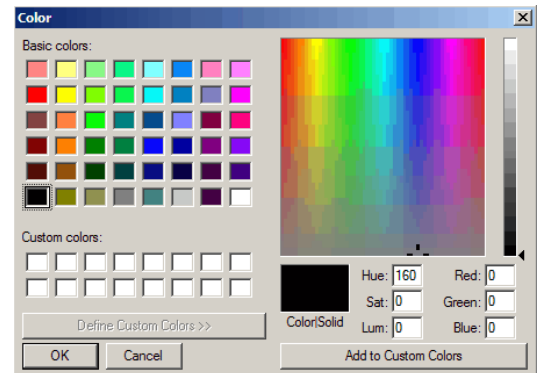
The colour form appears. This allows you to select the colour for the vectors on that layer.



- Select any suitable colour and then **OK**.
- Switch on all the **Layers** using the **Toggle All Visibility**. 
- Select **Open**  from the **Vector layers toolbar**.
- From **ArtCAM Data**, select the file **tel-insert.eps** and select **Open**.

The vectors are **imported** as a group on a **new layer** (same as **filename**), so to use them individually, they need to be **ungrouped**.

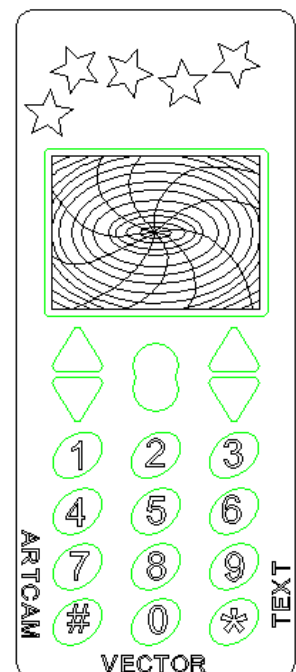

Vectors can also be **imported** from the main menu by first highlighting the required vectors and then selecting **Vectors > Import....** from the top menu.

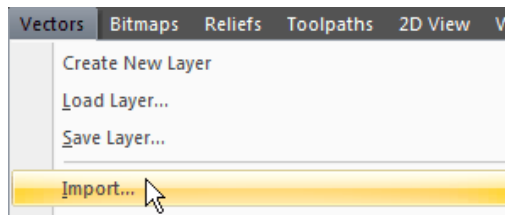

Similarly, vectors can also be exported by selecting the desired vectors and then selecting **Vectors > Export....** from the top menu.

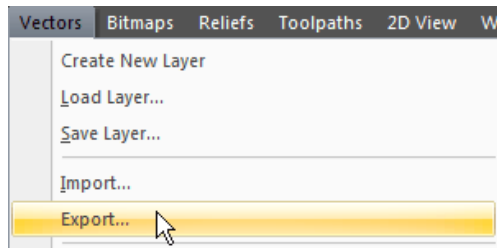

Selecting  from the **Vector layers toolbar**, will **export all vectors on that layer**.

- Select **File > Save**.
- Select **File > Close Model**.

Node Editing

The structure and appearance of a vector can be changed using the **Node editing options**. **Vectors** are made up of **nodes** and **spans** which are displayed only when ArtCAM switches to

Node Editing Mode. 

Upon **selecting a Vector**, **Node Editing** can be entered by selecting  from the **Design Tools Toolbar** on the left hand side, the **Right mouse select menu** or simply selecting **N** on the keyboard.

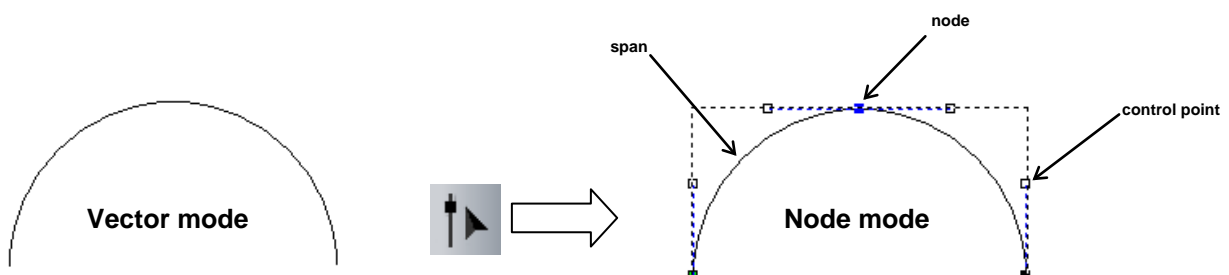

The following example illustrates the different options available for editing **nodes**, **spans** and **control points** within selected vectors.

Enamel-Pin Exercise

- Create a **New Model** with a **Height** of **20mm** and **Width** of **60mm**. (Origin in centre)
- Create a **Guideline** at **X 0** and **Y 0**.

- Select **Create Polyline**. 
- **Untick** the **Draw smooth polylines** option. **Draw smooth polylines**
- Enter **X** as **-25mm**, **Y** as **1mm** and select **Add**.
- Enter **dx** as **35** and select **Add**.

- Select **Create Polyline**. 
- Enter **X** as **-25mm**, **Y** as **-1mm** and select **Add**.
- Enter **dx** as **35** and select **Add**.

Note: Selecting the Spacebar will stop the Polyline creation at the last point. A new start point can then be created.

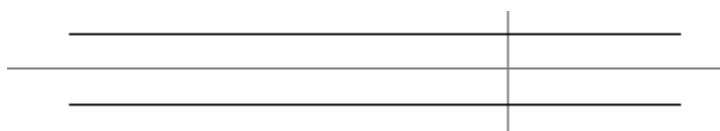

You can join these **two vectors** together with either an **arc**, **straight line** or by **moving** the **end points**.

- Select both vectors.
- Select **Join Vectors With A Curve**. 

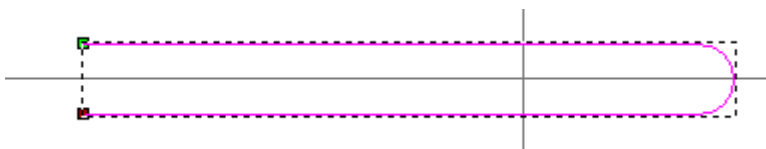

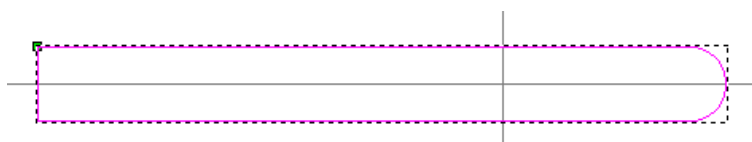

You've **joined** the **two vectors** together to make a **new vector**. You will **close** the **open vector**.

- Select the **new vector**.
- Select **Close vector with a Line**. 



The vector has been closed. You will now modify an **Ellipse** to produce a **leaf shape**.

- Select **Create Ellipse**. 
- Enter a **Start Point of X -4mm Y 4mm**, an **Ellipse Height of 3mm** and **Width of 12mm** with an **Angle of 340 degrees**.
- Create the **Ellipse shape** (single mouse click on model sheet)
- **Select the Ellipse** and then **Select Node Editing**. 

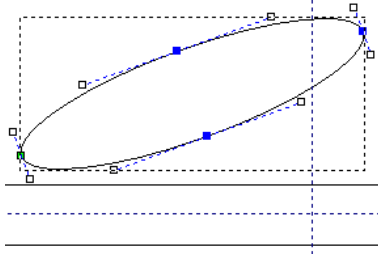

By pressing **N** on the keyboard on a selected vector, you will switch between **Node Editing** mode and **Select Vectors** mode.

You will open up the **Ellipse** halfway by removing spans using the **right mouse button** menu.

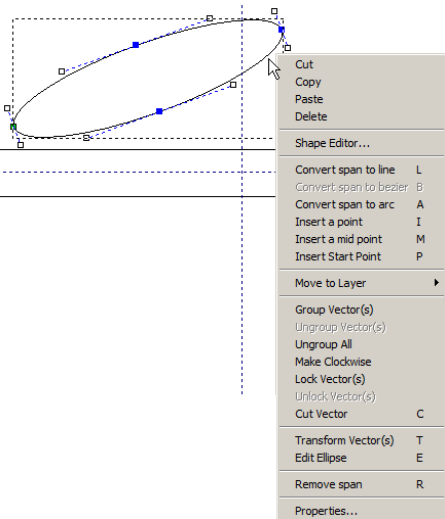

The part of the vector between two node points is called a **span**. If a **span** was removed, the vector will become **open**.

In **Node Editing** mode, if you move your mouse over a **node point** and click the **right mouse button** a local set of menus appears.

- **Right mouse click** over the **right bottom span** of the **Ellipse** and select **Remove Span** from the menu. (The span mode is indicated by ~)

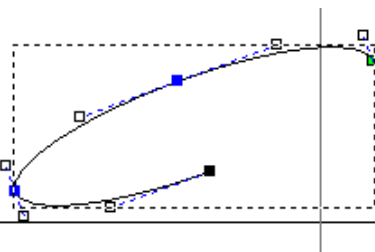

The **Ellipse** vector is opened at the required area. You'll need to delete the other lower span.

- **Right mouse click** over the **left bottom span** of the **Ellipse** and select **Remove Span** from menu.

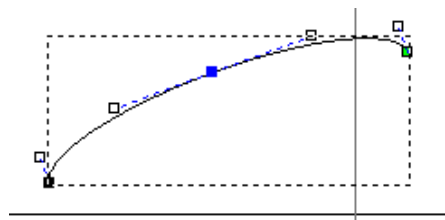

Only half of the original **Ellipse** remains. You will **close** this half **Ellipse** with a **line** in the **Select Vectors** mode.

- Select **Select Vectors.**



- With the vector selected, select **Close Vector with a Line.**

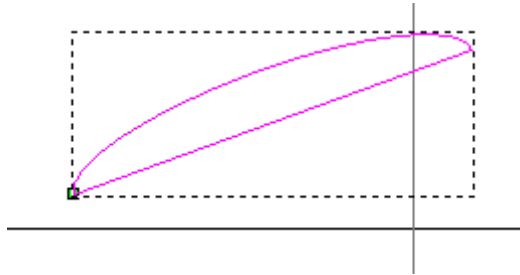

The vector is now closed. You will now create a **Polyline** to mirror the vector across.

- Select **Create Polyline.**
- Enter **X** as **-10.3mm**, **Y** as **1.5mm** and select **Add.**
- Enter **X** as **3.6mm**, **Y** as **6.6mm** and select **Add.**



- **Shift-Select** the **Polyline**, the **leaf shape** and then **Mirror Vectors.**
- Tick the **Copy the Original Vectors** option and select **About Line.**
- **Close** the form.



- Select the **Polyline** and select **Cut.**



The leaf shape has been generated. This will now be mirrored to the other side.

- Select **Create Polyline.**
- Snapping to the **horizontal Guideline**, create a single line across the model.
- Select the **new horizontal vector** and the **leaf shapes.**





- Select **Mirror Vectors.**



- Select **Copy the Original Vectors** and the **About Line** option.

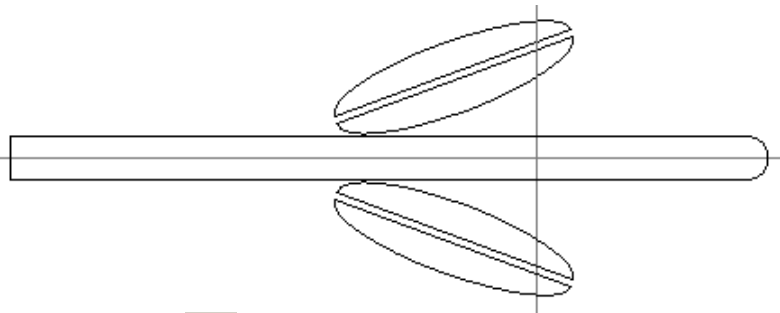



- Select **Create Circles.** 
- Set the **Circle Centre** as **X 10mm Y 0**, select **Radius** and enter **1.5mm**.
- Deselect **Create with arcs**, before **creating the circle**.
- Create a new **Circle** with **Centre** at **X 16mm Y 0**, and **Radius** of **6mm**.
- Select **Create** followed by **Close**.

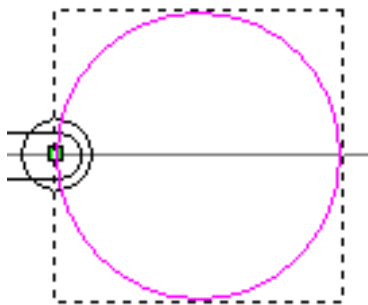

The **smaller circle** will be subtracted from the **larger circle**.

- Select the **larger circle** and then **shift select the smaller circle**.
- Select **Subtract vectors.** 
- Select **Node mode.** 

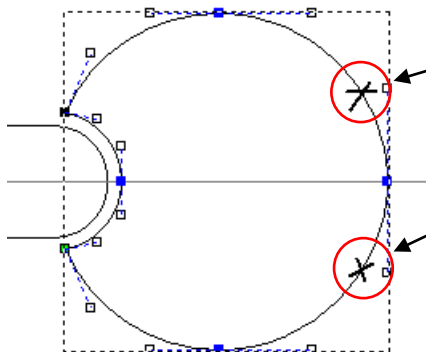

- Move the mouse over the **top marked area** and from the **right mouse menu** select **insert a point**.
- Move the mouse over the **bottom marked area** and from the **right mouse menu** select **insert a point**.

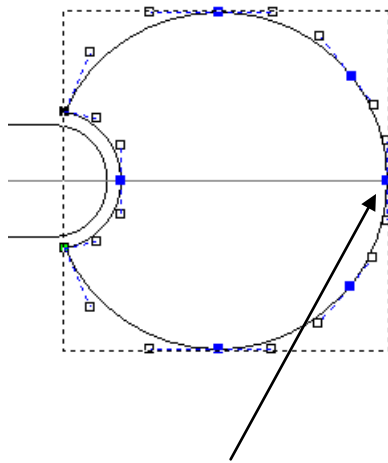

The addition of these extra node points will allow you to move the node point in between the new points and it will only stretch the vector within that region.

- Select the **middle node**.
- Drag the point **along the horizontal vector** (towards the origin) and **release** the mouse at a suitable position as shown in the image below.
- **Delete** the horizontal vector.

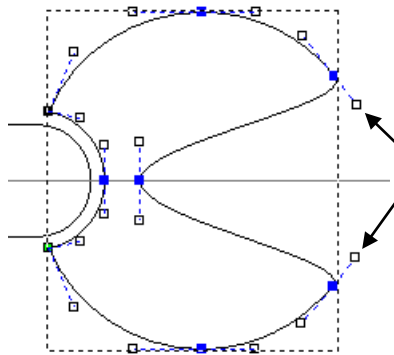

The **two control points** can be dragged to produce a more realistic curve.

- Select each **control point** and move around as shown in the image below.

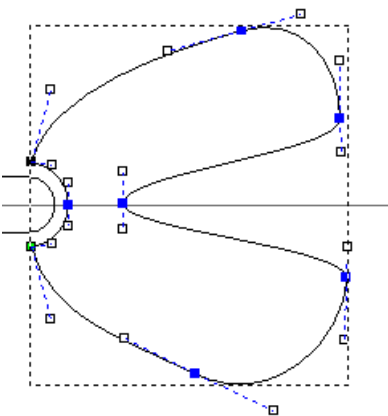

The shape is complete. You'll have to create another **Polyline** to build the inner part, using the smooth option.

- Select Create Polyline.



- Tick the **Draw smooth Polylines** option.
- Select **several points** on the model to make the shape roughly as shown.

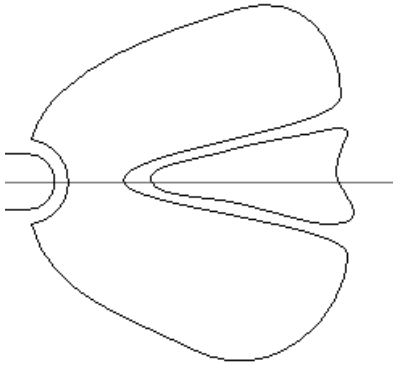



The last point is not smoothed when it is joined. You can smooth it in the **Node Editing** mode.

When you are in the **Node Editing** mode the smooth point shows as **blue** and a non-smooth point shows as **black**.

You can now **Offset** all of the **vectors**.

- Click on the **start point** to complete a single closed vector.

- Select Vectors. 
- Select **all** the **vectors**.
- Select **Offset Vectors**. 
- Select an **Offset Distance** as 1mm, **Offset Direction** as **Outwards/Right** and **Offset Corners** as **Radiused**.
- Select **Offset**, followed by **Close**.

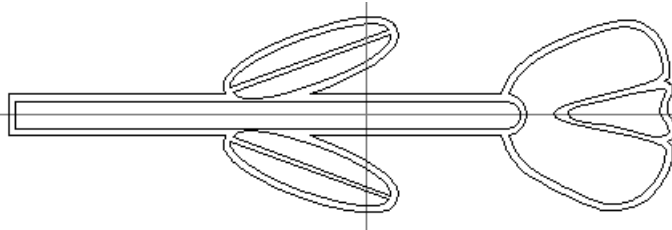

The design is complete.

Selected Node Editing

When a node is selected it turns red and can be moved dynamically. Shift and select allows the user to select several nodes in a curve, ctrl and select allows the user to pick individual nodes, to be moved simultaneously.

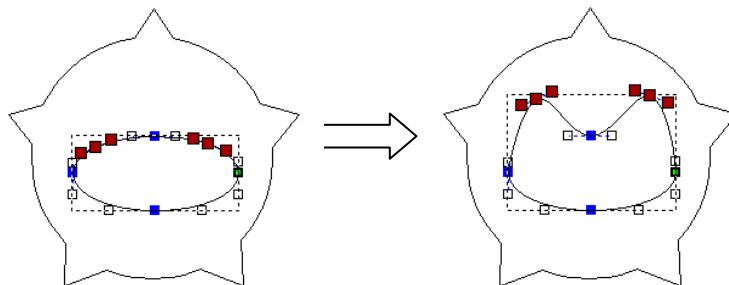

Selecting X on the keyboard edits the selected points with the X coordinate of the last node.

Selecting Y on the keyboard edits the selected points with the Y coordinate of the last node.

Vector Clipping and Slicing

Vector Clipping  is used to trim a **group of vectors** within a defined **vector**.

Vector Slicing  is used to split a **vector** across a selected cutting **vector**.

Vector Clipping Exercise

- Create the following vectors in a **New Model** of size **100 x 100** and **Origin** at the centre.

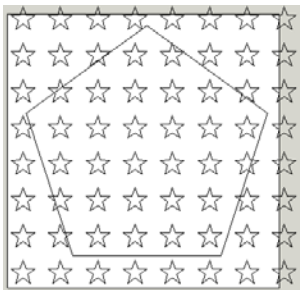

The sizes do not really matter as long as there are a few stars within the pentagon.

- Select **Vector Clipping**. 

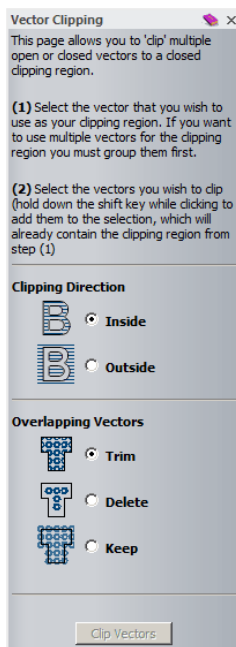

The vector clipping form appears with instruction on how to use the command and the different results available with the options given.

- Select the **Polygon** and then **shift – select all** of the other **vectors** (can drag a box).
- Select Clipping Direction as **Inside** and **Overlapping Vectors as Trim**.
- Select **Clip Vectors**.

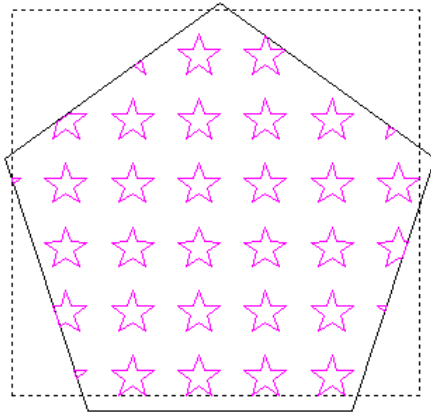

The stars that are whole within the polygon are retained and those that cross the polygon are trimmed back as shown.

Vector Slicing Exercise

- In a **New Model** of size **100 x 100** and **Origin** at the centre sketch the following **vectors**.

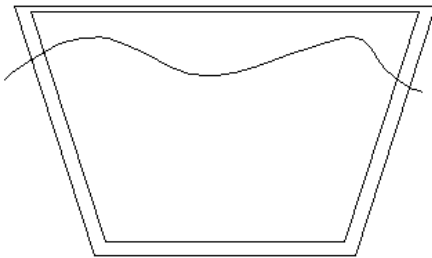

- **Shift - Select** both the closed vectors followed by the open (slicing) vector.
- Select **Slice Selected Vectors**. 

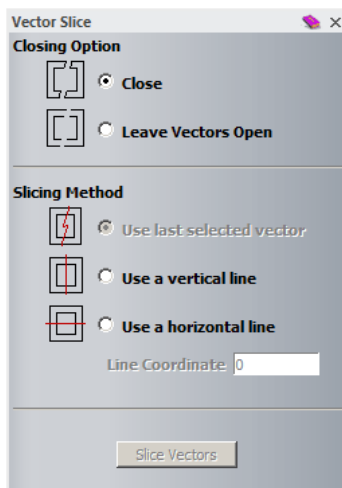

The **Vector Slice** page appears displaying the options available. The **Use last selected vector** option is only available when more than one vector is selected. Otherwise it will be greyed out.

- Select the options **Close** and **Use last selected vector**.
- Select **Slice Vectors**.
- Nudge the **two new vectors up** and **down** using the keyboard up and down arrow keys to see the result.

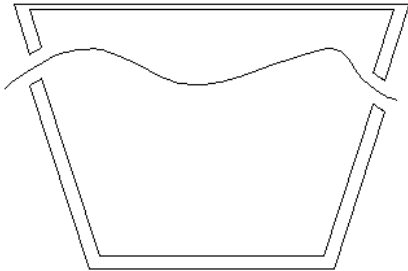

The vectors have been sliced and rejoined.

4. Bitmaps

Introduction

Coloured Pictures can be generated or edited within **ArtCAM** using the **Bitmap toolbar**. **Bitmaps** can be loaded in using any of the following formats **bmp**, **.tif**, **.pcx**, **.gif**, and **.jpg** and **.pdf**.

ArtCAM can also generate vectors of the boundaries of the selected colour and the ability to link colours together temporarily which enables you to define different areas without changing the original picture. This is called **Colour Linking**.

Bitmaps are loaded directly into **ArtCAM** by using **File – Open**  or importing the image (onto a new layer) from the **Bitmap layers tab**.

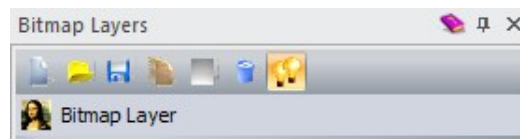

The following exercise illustrates the above functionality on two examples.

Bitmap to Vector – Exercise 1

- Select **New Model**. 
- Enter a **Height** of **200mm**, a **Width** of **200mm** and a **Thickness** of **12mm**.
- Set the **Origin** to the **bottom left** and both **Z Zero** and **Model Position** at the **Top Of Block**.

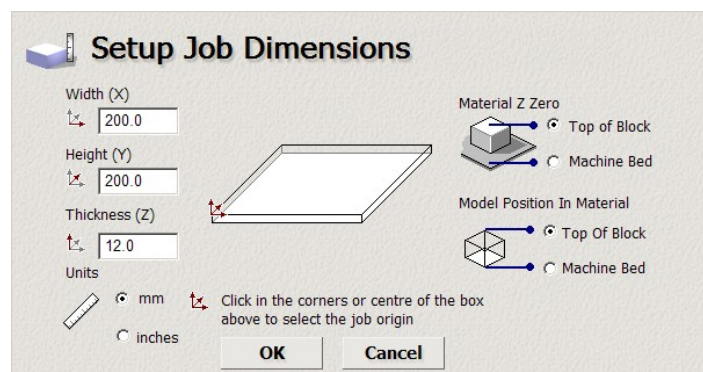

- **Activate** the **Bitmap Layers fly out panel** if not already visible.

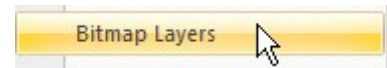

- **Select** Import Image  **to display the Load Bitmap Layer Dialogue Box.**



- Locate the file **Art.bmp** from: **D:\users\training\ArtCAM Data.**
- Still within the **dialogue box**, **Expand** the Scaling list and select **Fit.**

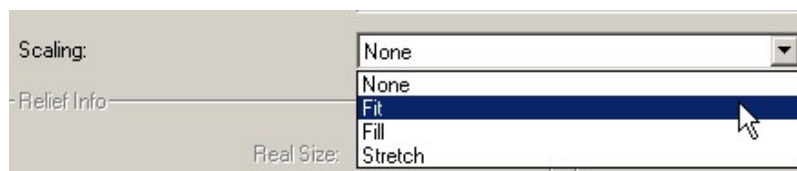

- Select **Open** to load / Import the Bitmap.



The Bitmap is **loaded onto its own Bitmap Layer**. All associated colours with this Bitmap are displayed in the Palette.

The **Colours will be reduced** to assist and **accelerate** with the **Vectorization process**.

- **Activate the Assistant Tab and Select Reduce Number**



from the **Bitmap Tools** area.



(Or from the Main menu *Bitmaps>Colour>Reduce Number*)



- **Enter 5 for a New Maximum number of colours For Image.**
- **Select OK.**

A message box is displayed warning that reducing the number of colours in the bitmap image will reset all colour links and attributes.

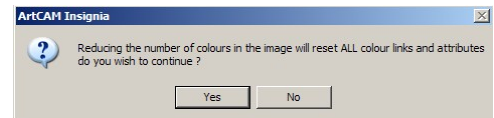

- **Select Yes.** (as there are no current links in this case)

- **Select OK**

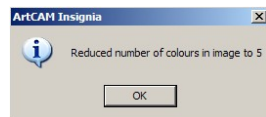

ArtCAM takes **all the colours of a similar shade** and produces a new average of only 5 colours. These are now shown in the palette.



Upon close inspection the grey colour  can be seen as a thin border around the letters.

This will be eliminated by colour linking.

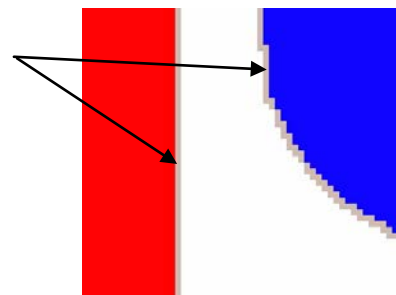

- With the **left mouse button**, select the **white colour** (third from left) in the palette to make it a primary colour.



- **Double right mouse click** on the **grey colour** (fourth from left) to **link** it to the **primary colour**.



All previous grey pixels have changed to the primary colour of white.

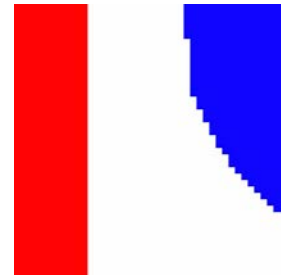

- From the **Vector creation toolbar** at the top of the screen (or assistant tab) select **Bitmap to Vector**. 

- Enter a **Pixel Tolerance of 1**, select the option **Keep Lines** and enter a **Min Pixel Length of 3** and select **Create Boundary**.

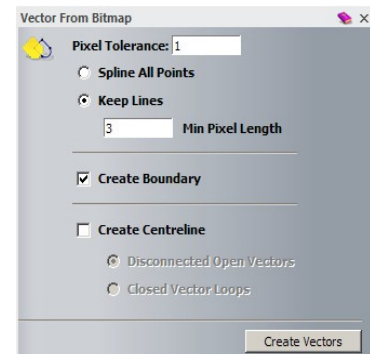

- Select **Create Vectors** and **close the form**.

- Toggle **Bitmap visibility**  in the **Bitmap Layers Tab** to hide the original image.



The Vectors are generated around the primary colour (in this case White)

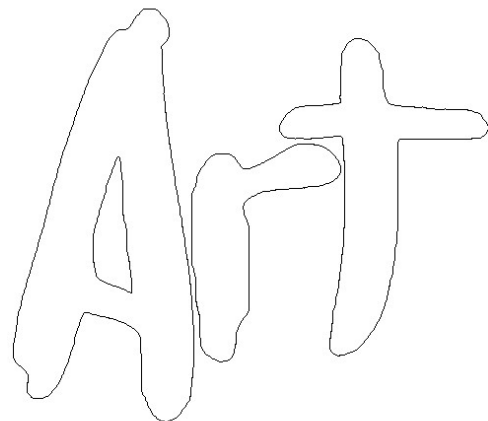

Bitmap to Vector – Exercise 2

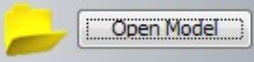
- Select **Open Model**. 
- Select the folder: **D:\users\training\ArtCAM Data**, and change **Files of type**: to **Bitmap Files**.
- Select the file **toucan.gif**, followed by **Open**.
- Leave the **Set Model Size** dimensions as **default**, and select **OK**.
- Left mouse click on the first green colour in the colour palette (make primary)



- **Double right mouse click** on the next **5 green colours** (to link to primary)
- Double right mouse click on the **red** and **yellow** colours.



The **toucan** is now surrounded by a single **green** colour.

For the **body part** of the toucan, the **feet** and the **red beak** are not required, so they were also linked to the green.

A single **vector** from the **boundary** of the **Primary** colour will now be created.

- From the **Vector creation toolbar** at the top of the screen (or assistant tab) select **Bitmap to Vector**. 

- Enter a **Pixel Tolerance** of **1**, select the option **Keep Lines** and enter a **Min Pixel Length** of **5** and select **Create Boundary**.
- Select **Create Vectors** and **close the form**.
- **Toggle Bitmap visibility**  in the **Bitmap Layers Tab** to hide the Toucan image.

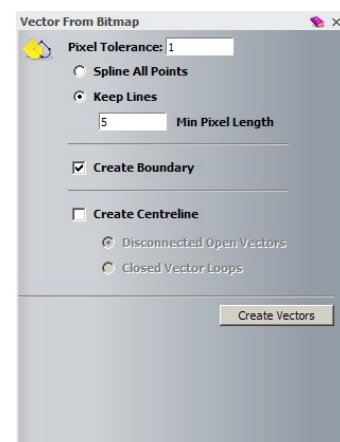

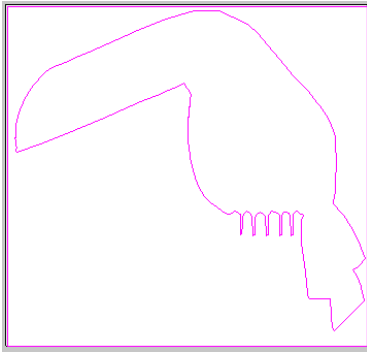

A single closed vector has been generated on the primary colour(s) boundary. **Adjusting the pixel tolerance** will define how close the vector will follow the primary colour boundary.

5. The Toolpath Options

Introduction

ArtCAM can produce a variety of machining strategies **directly from vectors** or on an imported **3D Relief**. The machining set up and strategy commands are accessed from the **Toolpaths** tab in the Project tree or by activating the **Toolpath's fly out panel**. The **toolpaths** that are generated are stored within the **ArtCAM** model and can easily be edited. To drive a specific machine tool one or more **toolpaths** are output as a **post-processed** file translated to the format of the relevant controller.

Toolpaths page

The **Toolpaths** page is segregated into four main categories - **Toolpath Operations**, **2D Toolpaths**, **3D Toolpaths** and **Toolpath Simulation**.

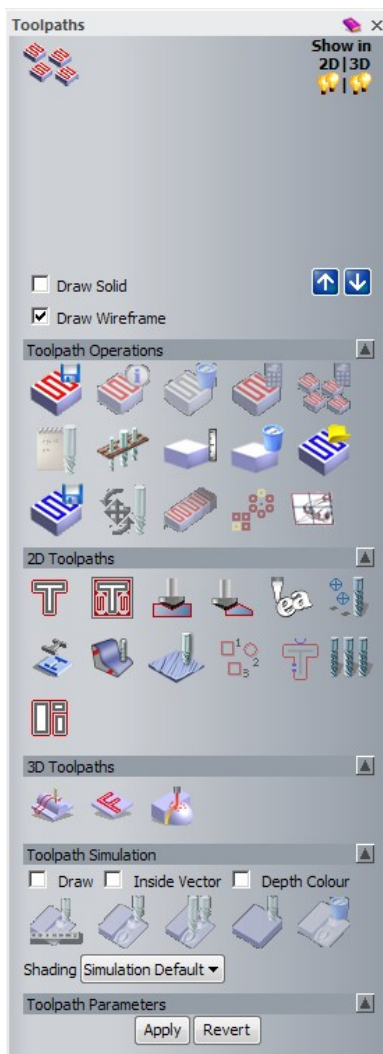

When a **Toolpath** is calculated it will be displayed in this upper area of the **Toolpaths** page. The **Toolpath Names** can be selected for **Toolpath Simulation**, **Toolpath Operations** or to re-opened for editing.

The **Toolpath Operations** area contain operation including Save (to post process), Delete, Tool Database, Material setup and creating machining templates.

The **2D Toolpaths** section contains commands to generate **2D Toolpaths** directly from **Vectors** including Profiling, Area clearance, Bevel and V-bit Carving, Inlays and Texture toolpath.

The **3D Toolpath** section contains commands to generate the toolpaths over an **imported 3D Relief**.

The **Toolpath Simulation** section provides controls for viewing **Toolpath** animation and material removal.

Toolpath Parameters allows changes made to the selected Toolpath Parameters such as Tool number.

It may be required to modify the origin of the model to a position more appropriate as a machining origin. This is achieved by inputting suitable **X Y Z** values in the

Set Model Position dialog box.

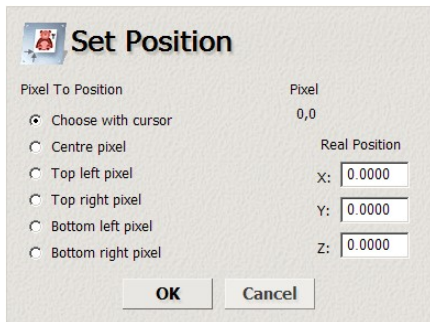

This can be accessed from the top drop down menu **Model > Set position**.

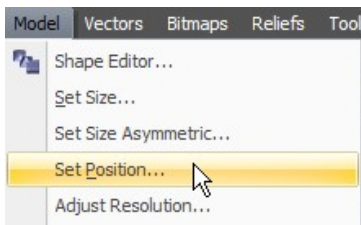

6. 2D Vector Machining

Introduction

ArtCAM Insignia has a series of powerful options to create **2D Toolpaths** that are **directly calculated from vectors**.

Forest Sign – 2D Area Clearance

- Open the model **Forest_Sign.art** from: D:\users\training\ArtCAM Data.



- Hold down the **shift key** and **multi-select** the **Inner Ellipse, Squirrel, Tree, and Text vectors**.

- **Activate** the **Toolpaths fly out panel** if not already visible.

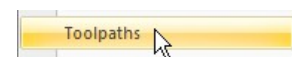

- **Select Area Clearance Toolpath**  from the **2D Toolpaths Tab**.

- Set the **Start Depth as 0, Finish Depth as 2mm and Allowance as 0.**
- Set the **Final Tool Allowance as 0.25mm and Tolerance as 0.01mm.**
- Select the downward arrow under **Machine Safe Z** and enter a value of **20mm for Safe Z** and **X-100, Y-50 and Z20 for the Home Position.**

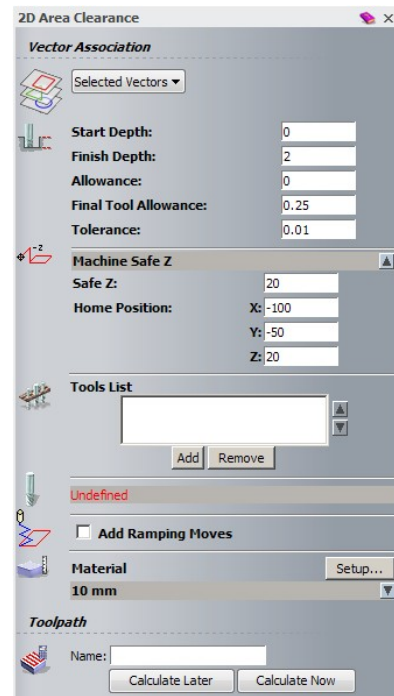

The following information was entered:

Start Depth – is the height from where the **Stepdown** is calculated.

Finish Depth – is the **maximum depth** for machining to occur.

Allowance – is the amount of **2D stock** remaining on the **vectors** for the final tool.

The **Material Allowance** is the specified thickness of material that is left on over the actual **relief** when the toolpath is created.

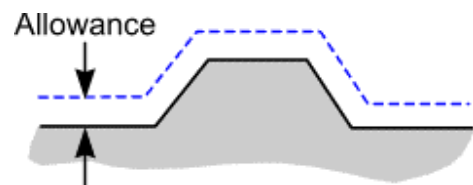

Final Tool Allowance – is the amount of **2D stock** remaining for all except the final tool (normally used to produce a better surface finish)

Tolerance – the **toolpath** will create a finish to within **0.01** the original **vector**.

Tolerance determines how accurately a cutter path follows the true shape of the **vector or relief**, the actual value being the maximum permissible deviation from the form.

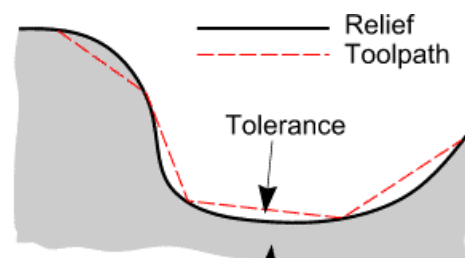

Safe Z – is the height at which **rapid moves** across the component are permitted.

Home Position: specifies the coordinates of the **Start and End** point of the **toolpath**.

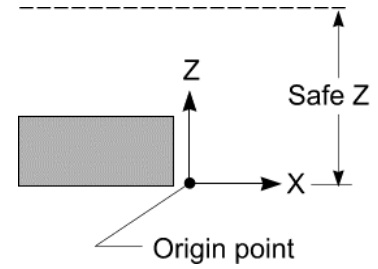

- Select **Add** from the **Tools List** to launch the **Tool Database**.

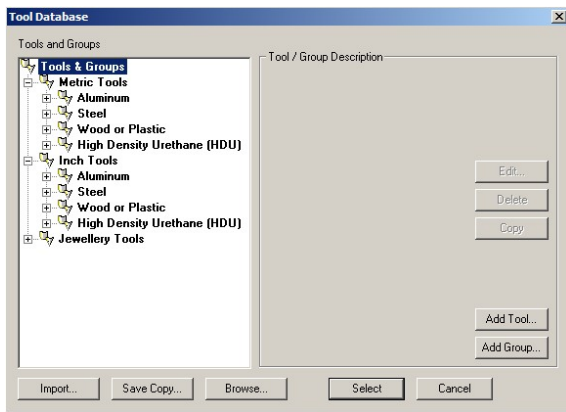

The default **Tool Database** contains a large selection of tools and associated parameters for a variety of materials. The selection can be modified, deleted, or added to by the user as required.

You can also have access to the **Tool Database**

by selecting the icon  in the **Toolpath Operations Tab**.

- By selecting the  sign next to the names, **Browse to Metric Tools > Wood or Plastic > Roughing and 2D Finishing >**

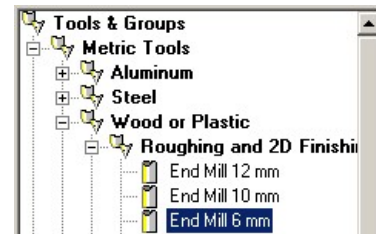

- **Select the End Mill 6mm.**

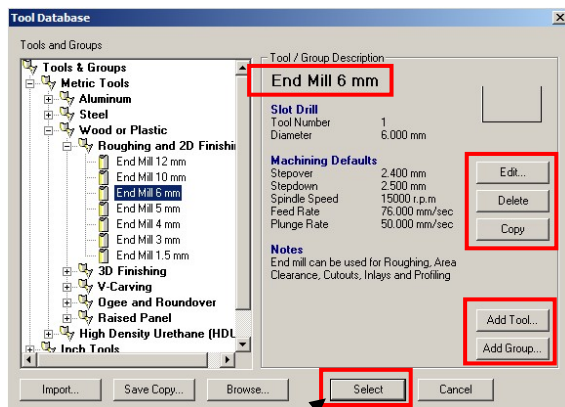

When a tool is **selected** (highlighted) in the left hand window, the tool data and description is displayed on the right-hand side of the form.

Individual tools can be **Edited, Deleted or Copied**.

New Groups and Tools can also be created for **customisation**.

- Press **Select** on the form to **accept the 6mm End Mill** as the **Roughing operation tool**.

The **6mm End Mill tool** and its parameters are now **loaded** into the **Tools List**.



- Select the **down arrow**  to reveal the default settings for the selected tool.

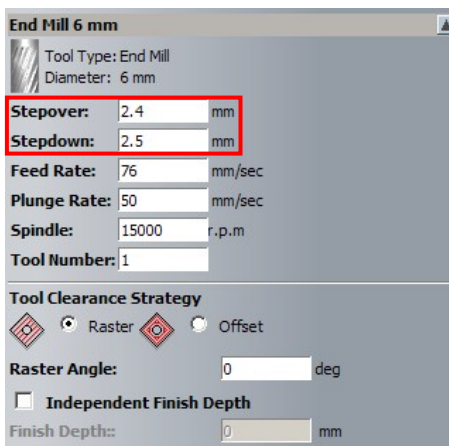

The **default tool parameters** (for Wood and Plastic 6mm End Mill) are shown. Changing values in this form do no affect the original tool stored in the database.

The **Stepover** is the distance between passes.

The **Stepdown** is the incremental depth of cut (slices).

A **Tool number** is essential if outputting to a machine tool fitted with an automatic tool changer.

- Select **Add** from the **Tools List** to launch the **Tool Database**.
- From the **tool database Wood or Plastic > Roughing and 2D Finishing** area and load in the **End Mill 1.5mm tools**.

The **2D Area Clearance** strategy allows multiple **tools** to be selected.



The selected **tools** are displayed. The adjacent arrows can be used to change the sequence if required.

The **Tools List** contains two different **End Mills**. When the **toolpath** is calculated, the larger **6mm End Mill** is used first to perform the main **2D Area Clearance** machining. Any subsequent, smaller tools in the **Tools List** will only operate locally in areas that are out of reach to the previous tool (i.e. **Rest Milling**).

There are **two options** available for **2D Area Clearance** machining strategies, **Raster** which steps a **linear cutterpath backwards and forwards** across the component or **Offset** which steps the **cutterpath parallel to the selected vector(s)**.

Raster Strategy



With the **Raster** strategy, the tool moves across the **Z Slices** in parallel, straight line moves separated by the **Stepover** distance. The toolpath is automatically limited away from the relief / Vector by the **tool radius** plus the **Material Allowance**, as shown.

Offset Strategy



With the **Offset** strategy, the tool moves are offset inwards from the shape of the **Complete Relief** or limiting **Vector**, and outwards from the shape of the **Relief / Vector** contour. Individual tracks are separated by the **Step over** distance.

- Select a **Raster** strategy for both tools and leave the **Raster angle at 0** ($X=0$).
- Leave the **Independent Finish Depth options unticked**.

This allows the option to specify an **Independent depth** for a **particular tool**.

- Set up the **Material** to have a **Thickness of 10mm**, the **Z Zero at the top**, and **Model Position at the bottom**.
- Enter the Name **EM6EM1_5-AreaClear**.
- Select **Calculate Now**.

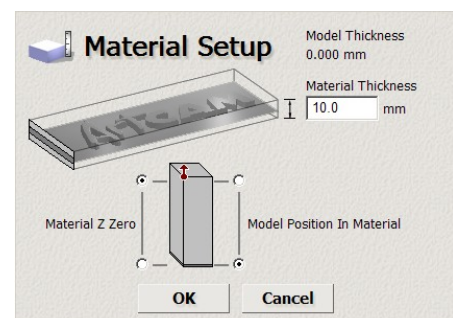



The **2D Area Clearance** toolpaths will appear as shown above. As the primary tool (**End Mill 6mm**) had a default **Stepdown** value of **2.4mm**, all of the machining has been performed at the single depth of **-2mm**. If the above **Stepdown** value were **1mm** then the machining would have been performed at depths of both **-1mm** and **-2mm**.

- **Close**  the **2D Area clearance** form.

The Toolpaths are listed in Toolpaths fly out panel.



The **Toolpaths** window now contains two named **toolpaths**, which by default are also displayed in both the **2D** and **3D** views – by using the check boxes.

- In the **3D view**, select the **Isometric View**.

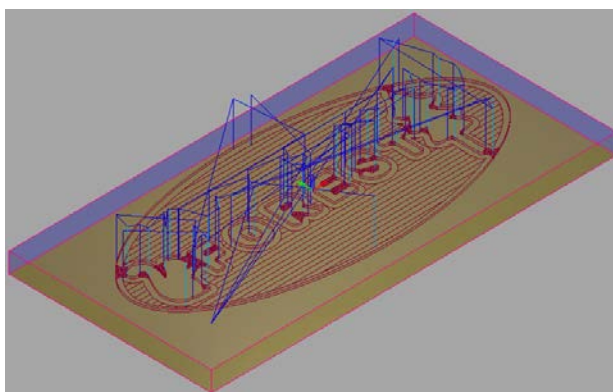

The generated **Toolpath** components are colour coded to assist with both visualisation and identification for **post-processing**.

Cutting **Feed Rate** moves are **Red**, **Safe Z** rapid moves are **Dark Blue**, and **Plunge/Ramp** moves are **Pale Blue**.

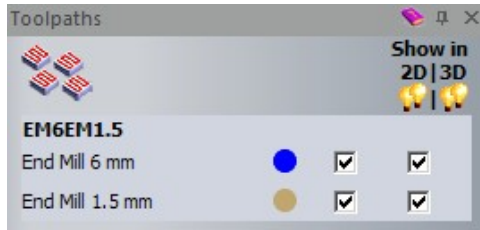

The **Toolpath** appears at the top of the **Toolpaths** page. The **Toolpath** can be shown or hidden by ticking or unticking the relevant **Show in – 2D/3D** column boxes.

The **Objects to Draw** icon  at the top of the **3D View**, allows the user to toggle the visibility of all entity types (not just machining toolpaths).

- Click **Objects To Draw**  on the **3D View** Toolbar.

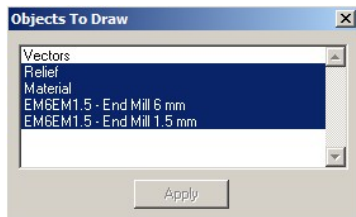

You can toggle between different objects by clicking on them and by selecting **Apply** to display the selected items in the **3D View**. Currently, only the Vectors are undrawn.

Simulating the Toolpaths.

Toolpath movement and material removal can be **simulated** in the **ArtCAM 3D View**. Options are available in the **Toolpath Simulation Tab** at the bottom of the **Toolpaths fly out menu**.

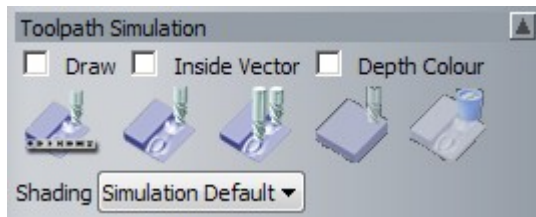

Options available in this menu are **simulate, reset and delete**.

The shading can also be changed to reflect the final material.

- Select **Simulation Control bar**  from **Toolpath Simulation**.

The following form will be displayed:

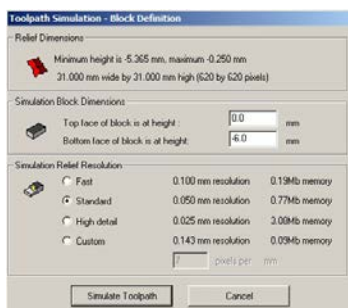

Relief Dimensions: shows the overall dimensions of the relief.
Simulation Block Dimensions: gives the size of the block.
 This should be at least as big as the minimum and maximum height of the relief plus any height (or depth) of the engraving features.

Simulation Relief Resolution: specifies the quality of the image that you require. The lower the resolution, the greater the speed of calculation.

- Select **Simulate Toolpath.**

Simulate Toolpath

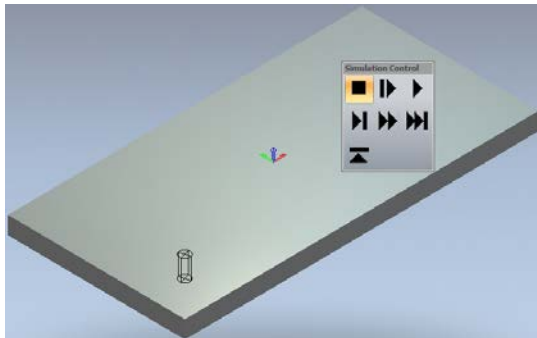

With this option the highlighted **tool is drawn** (End Mill 6mm first), along with a control panel to control the speed of the simulation.

For example, Selecting  will simulate at normal cutting speed.

- In this case, select **Play Simulation at Fast speed.**

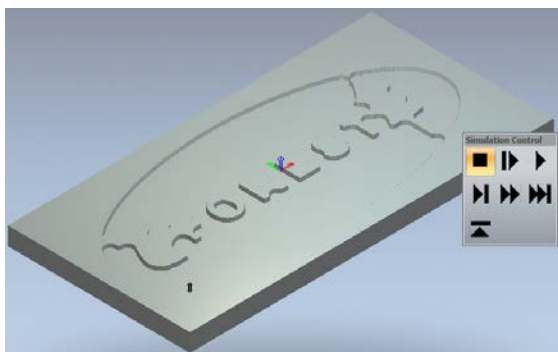

The **End Mill 6 mm** is simulated.

This toolpath has machined the inner form leaving a **2D stock** of **0.25mm** to be finished by the **End Mill 1.5mm toolpath.**

- Select **Play Simulation at Fast speed.**

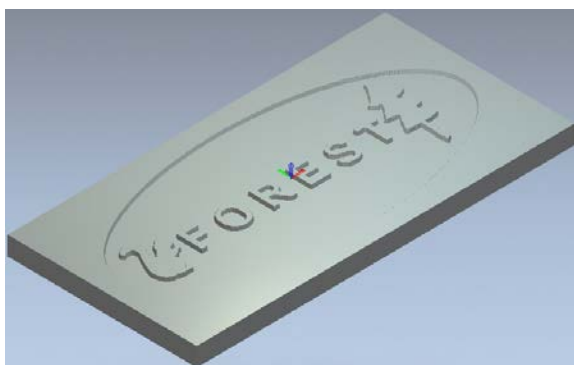

The **End Mill 1.5 mm toolpath** has successfully rest machined the remaining areas inaccessible to the previous cutter and removed the final **0.25mm stock allowance.**

Forest Sign – 2D Profiling

- Select the **2D View** and select the **Outer Ellipse vector**.



A **2D Profiling** strategy will be used to drive the tool around the outside of the sign.

- Select **Create Profile Toolpath**  from the **2D Toolpaths Tab**.

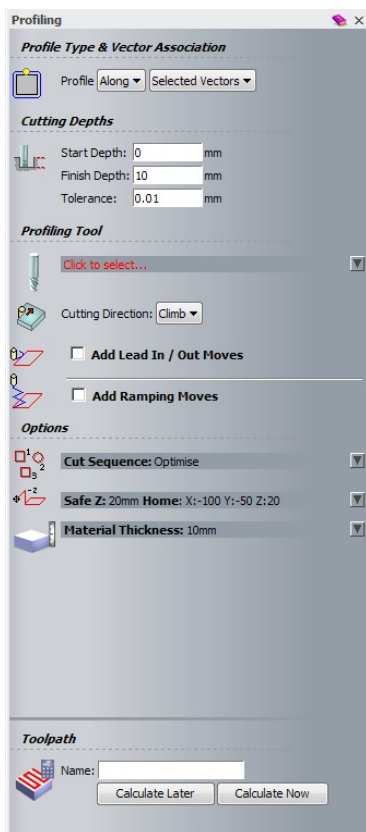

A **Profiling** toolpath can be generated to the defined depth, on the **Inside, Outside** or **Along** a closed vector. There is also the option to apply a **Climb Mill** or **Conventional** direction of cut. For an **open vector**, **Inside** will offset the **toolpath** to the **right** of the **vector direction** whereas **Outside** will offset the **toolpath** to the **left** of the **vector** direction.

The depth of cut for each **profiling pass** is defined by the tool's stored parameters, for example if the tool has a step down of 2mm maximum, it would take 5 profiling passes to get down to a total depth of 10mm.

With a **2D Profiling toolpath** the option is available to approach required profile with a horizontal, arc **Lead In** and **Lead Out**. This would result in a **tool plunge** move occurring away from the profile followed by a smooth, tangential transition onto the actual tool track.

- Select **Profile side as Outside**.

Offset Allowance specifies an offset distance to the vector.

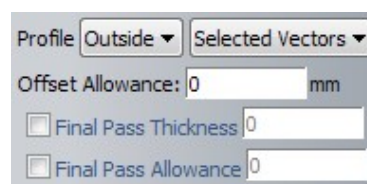

Final Pass Thickness allows a 'skin' of material removed only on the last pass.

Final Pass Allowance as above leaves a skin of material but in the Z Height only. Also is removed on the last pass.

- Leave the above settings as **zero including the Offset Allowance.**
- Select a **Start Depth of 0, Finish Depth of 10** and a **Tolerance of 0.01mm.**
- In **Profiling Tool**, select the **Select** button and load in the same **6mm End Mill** that was used earlier in the **2D Area Clearance** operation.

The cut direction of the tool can be selected here from either **Conventional** or **Climb Milling**.

When **2D Profiling** around a component, a superior finish is achieved for most materials if the direction of travel is the **left** of the **vector (Climb Milling)**. There are however a few materials (certain plastics) where a superior finish is achieved if the direction of travel is the **right** of the **vector (Conventional)**.

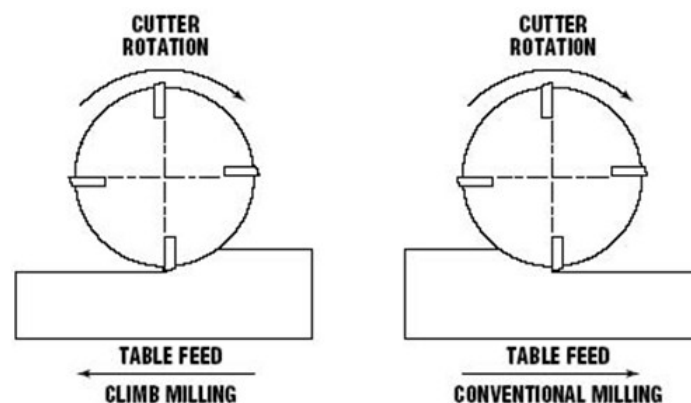

In **Conventional Milling**, the teeth of the tool meet the block of material at the bottom of the block. With this action, the teeth of the tool slide along until sufficient pressure builds up to break through the material surface.

In **Climb Milling**, the teeth of the tool meet the block of material of material at the top of the cut, at the thickest part of the cut.

Climb milling often provides a better finish, permits greater tool feed rates and prolongs the life of the tool.

- Select **Climb** at the Cutting direction.
- Leave the same (as before) **Material Thickness**, **Safe Z**, and **Home position**.
- **Enter** the Name **EM6Profile**.
- Select **Calculate Now**.

The **2D Profiling toolpath** has been generated **outside** the **Outer Ellipse**.



- **Close** the **Profiling form**.
- Select **Simulate Toolpath**.

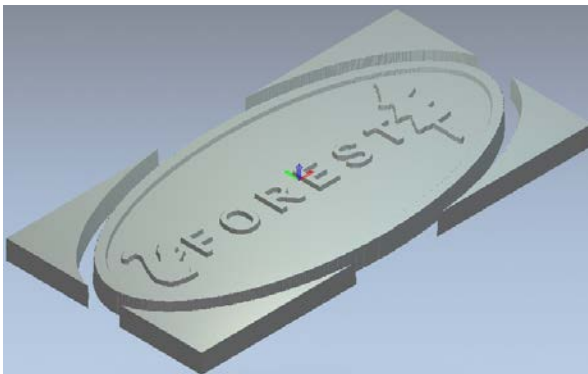

The simulation steps the **2D Profiling** pass down to a total depth of 10mm. If it is required to keep the sign attached to the outer material then **location lugs (Bridges)** can be applied retrospectively along the **toolpath**.

This will be shown next.

- Select File - Save As **TrainForestSign.art** in:
D:\users\training\COURSEWORK\ArtCAMPro-Jobs.
- **Do not** close the model.

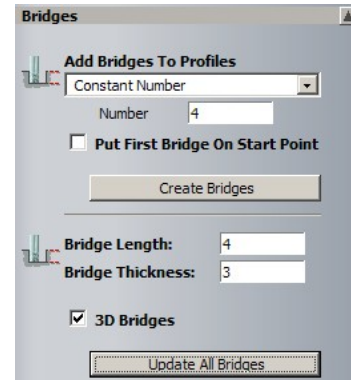

- Select **Profile Options**  from **2D Toolpaths**.
- **Expand the Bridges Tab** and enter the following settings.
- Select **Constant Number** from **Add Bridges to Profiles**.
- Enter Number **4**.
- Enter a **Thickness of 3mm** and **Length of 4mm**.
- **Tick** the option for **3D bridges** and then **Create Bridges** tab to create them.

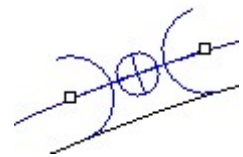

Bridges can be manually dragged (dragging centre circle) or increased in width by dragging the end square.



- **Close** the **Profile Options** form and switch to the 3D view.

- Select **Reset Simulation**  and **Simulate All Toolpaths**  to view the **added bridges**.



Further 2D machining strategies will be applied to this example.

- **Do not** close the model.

Bevel Carving

The **2mm** high text **'FOREST'** on the sign will have a **1mm** chamfer added by using the **2D Toolpaths** option called **Bevel Carving**.

The process requires the user to input a **Bevel Carving Tool**. The **tool** dimensions and/or stored values of **Stepdown** and **Stepover** will determine if the chamfer is machined as a series of 'stepped passes' or in a single 'pass'

- In the **2D View** select the **Text** item **'FOREST'**.

(Note: View shown is with toolpaths switched off)



- Select **Bevel Carving**  from the **2D Toolpaths Tab**.

- Enter a **Start Depth 0**, **Bevel Max Depth 1**, **Finish Depth 2mm**.

Bevel Depth is the max depth the carving tool will reach.

Wall height is the height of the profiled part of the carving which is zero, if no profiling tool is selected.

Finish depth is entire depth of the whole cutting operation

- Enter **Allowance of 0** and a **Tolerance of 0.01mm**.
- Enter a **Safe Z of 20** and a **Home Position of X-100 Y-50 Z20**.
- Select **Centreline**.

This determines the max width of path to engrave.

- Select a **V-Bit 32mm 120 degrees Carving Tool** and a **1.5mm End Mill Profiling Tool**.
- Set a **Climb Mill Cut Direction**.

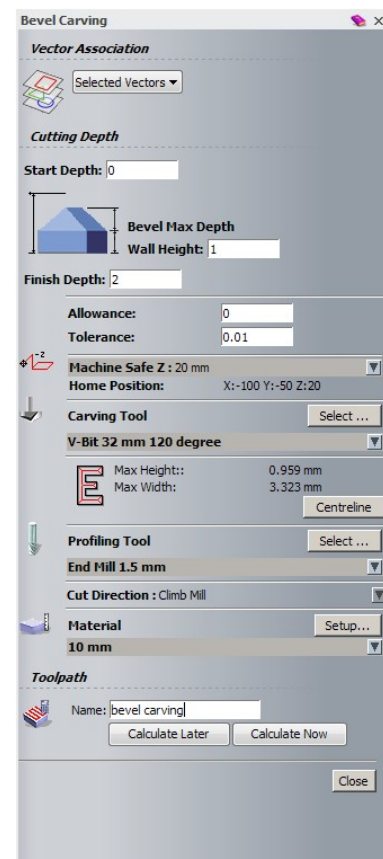

- Set up the **Material** to have a **Thickness** of **10**, the **Z Zero** should be at the **top**.
- Enter a Name as **Bevel_Carving**.
- Select **Calculate Now**.

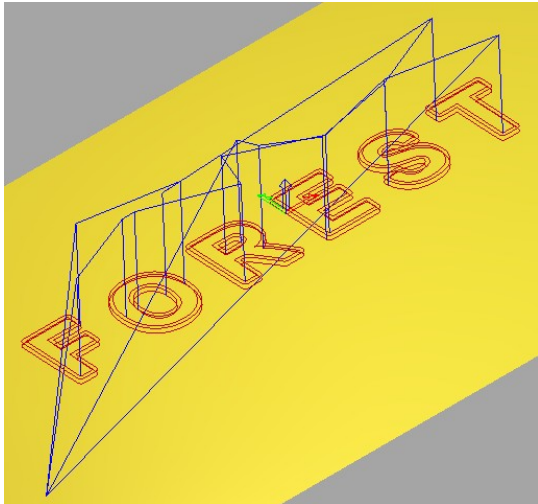

The toolpaths can be seen in the 3D view.

Note: view is shown with other toolpaths switched off.

- **Close** the **Bevel Carving** form.

- Select **Simulate All Toolpaths**.



The **1mm chamfer** can clearly be seen on the embossed 2mm high text.

- Select **File - Save** to update the model saved earlier.
- Select **File - Close Model**



V Bit Carving

The following example illustrates the **V-Bit Carving** strategy.

- Select **Create New Model** and Enter a **Width and Height of 100mm**.
- Set the resolution to **2004 x 2004 points** and **origin in the centre**.
- From the top pull down menu, Select **Vectors - Import** and **Open** the file:

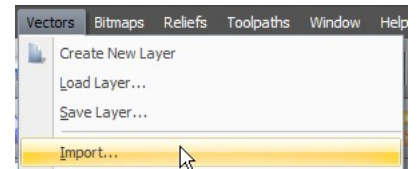
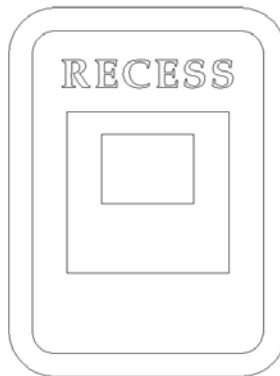
D:\users\training\ArtCAM Data\V-BitCarvingVectors.eps



- **Ungroup**  (or **Ctrl+U**) and then **select the Vectors**.
- Select **V-Bit Carving**  from the **2D Toolpaths Tab**.
- Leave the **Start Depth as 0**.
- Ensure **Tolerance is set as 0.01**.

The maximum permissible depth for machining to occur can be set by selecting **Limit tool maximum depth** and specify a **Maximum Depth** value.

- Select a **V-Bit 32mm 90degrees Carving Tool** from Wood or Plastic – V-Carving, and change the **Stepover to 1mm** and **Stepdown to 3mm**.
- Set the **Safe Z as 20mm** and the **Home Position as X-100 Y-50 Z20**.
- Enter a **Material Thickness of 20mm** and set the **Material Z Zero is at the top of the block**.
- Enter a **Name of VBitCarving** and select **Calculate Now**.
- **Do not Close** the form.

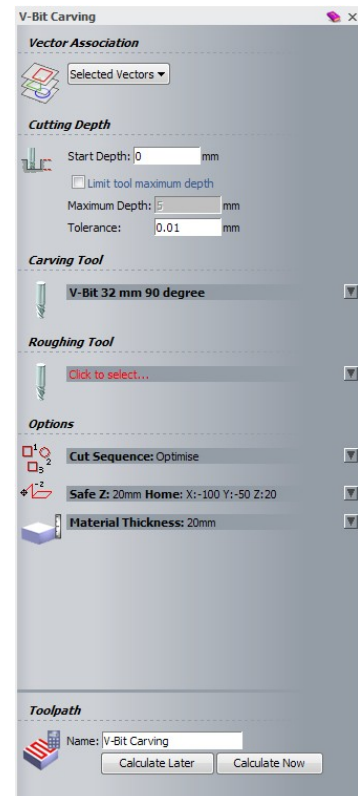

- **Simulate**  the calculated Toolpath.

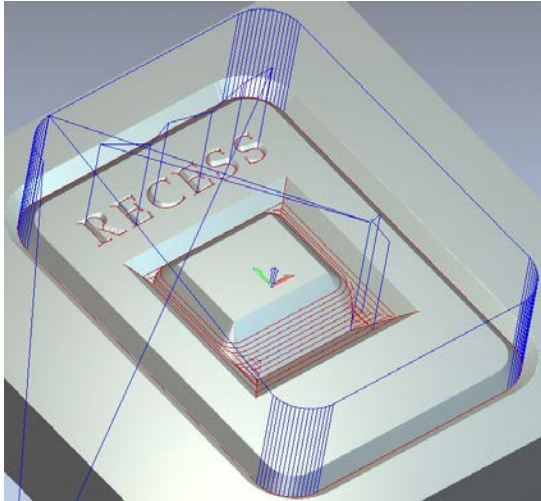

The toolpath is calculated creating '**V**' shaped **recesses** inside or between pairs of selected **vectors** and **text**. The maximum depth of the recesses is currently unlimited but the tool **does** perform an **area clearance** at incremental depths equal to the specified **Tool Stepdown** value. The **Area Clearance** can be removed by inputting a suitably high value for **Stepdown**.

- Edit the **Tool Stepdown** to **10mm**.
- Calculate the Toolpath again.
- **Do not Close** the page.

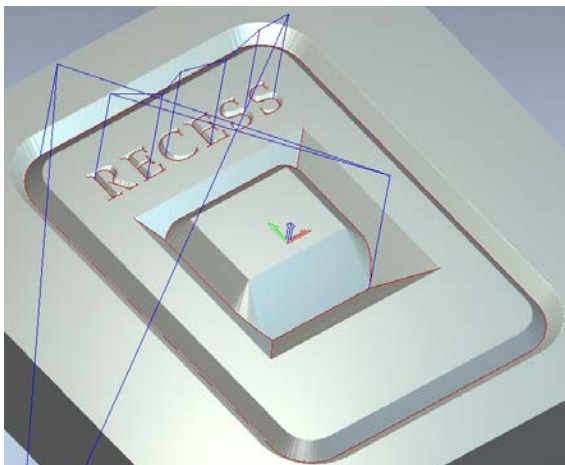
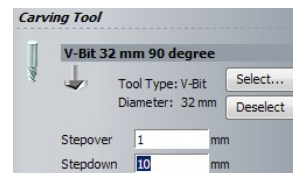

The toolpath has created the same end result, but without performing **area clearance** at **3mm incremental depths** (the tool **Stepdown** is now **10mm**).

- Select **File - Save As** and save the model with the File name **VbitCarving** in:

D:\users\training\COURSEWORK\ArtCAMPro-Jobs.

- Select **File – Close Model**.

7. 3D Machining

Introduction

ArtCAM Insignia allows **Raster** machining of **Imported 3D Models (Reliefs)**. Toolpaths are generated within the imported **ArtCAM model** and then a copy is saved out in the required machine tool format. A 3D model can be imported in two ways.

1. Directly from **Paste a Relief from a file.**



2. Converted from an **imported 3D model.**

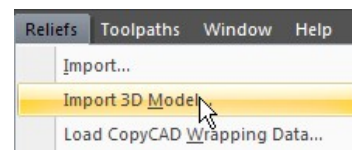

Toolpath Generation for a Pasted Relief

- Select **Create New Model.**
- Enter a **Width** of **50mm**, a **Height** of **50mm** and a **Thickness** of **10mm**.
- Set the **Material Z Zero** at the **top of the block** and **Model position** on the **Machine bed**.
- Set the **Origin** in the **centre** of the block diagram.

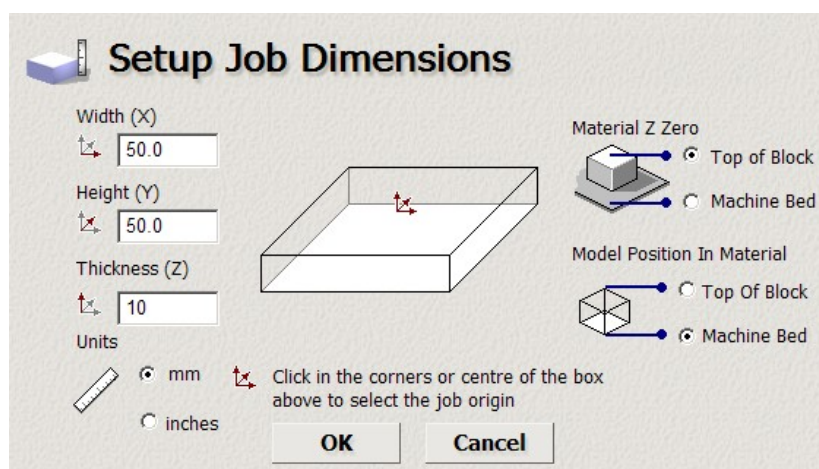

- Select **OK** to accept the settings

The **3D Relief** will now be imported into the model using the **Relief Creation Toolbar**.

- Select **Paste Relief From A File.** 
- Select **Load** and locate the file **ted.rlf** from: D:\users\training\ArtCAM Data.

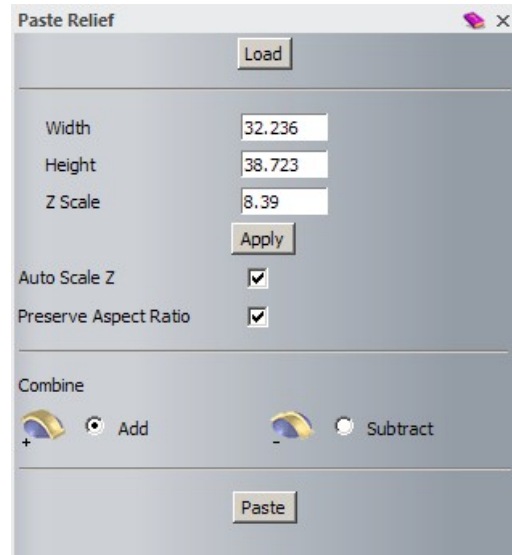

The size of the **Relief** is shown in the 3D view.

At this stage, the size can be altered and positioned to requirements.

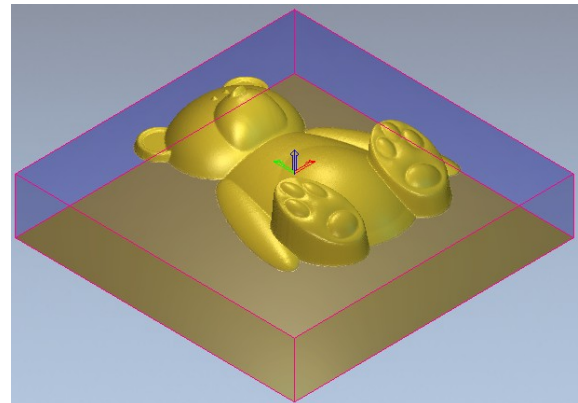

- Select **Paste** and then **Close** the form.

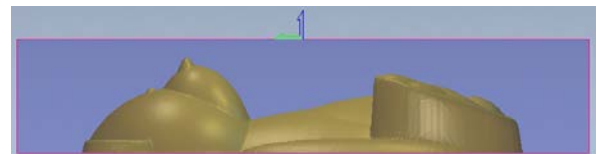

This Relief will be machined using **two Toolpaths** - An Initial **Roughing pass** followed by a **Finishing Toolpath**.

- From the **3D Toolpaths** area, select **Machine Relief**.



The **Machine Relief** page appears.

The **Machine Relief form** allows **Roughing** and/or **Finishing** operations (depending on tool selected) to be defined here.

The basic areas are summarised below but will be discussed in greater detail at each stage.

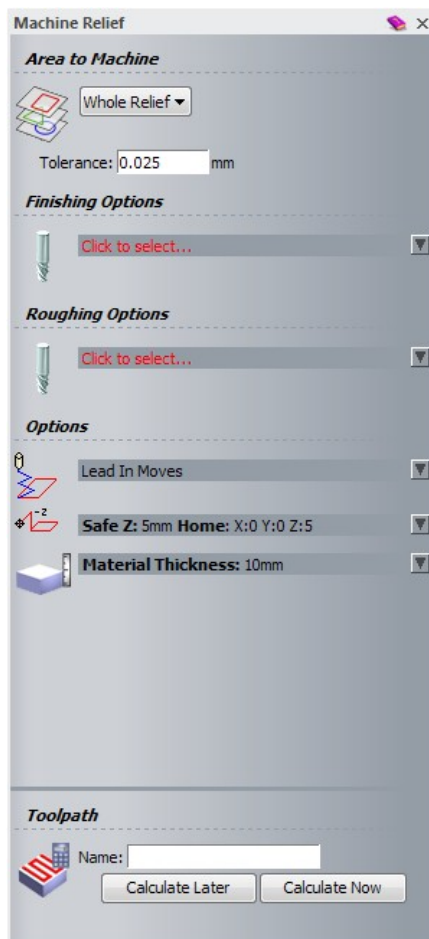

Area To Machine – this either applies to the **Relief** or area within the **Selected Vector**.

Finishing Options – allows the **Finishing tool, cutting strategy** and **angle** to be defined here.

Roughing Options – allows the **Roughing tool, cutting strategy** and **angle** to be defined here. The **Z slices** (thickness of each cut) is also defined here.

Lead In Moves – For harder materials, this option is used to apply a ramping move of the tool into the material instead of the default vertical plunge.

Safe Z, Home – Sets the **safe Z height** (rapid move) and **Start/End** position of the tool.

Material Thickness – This can be defined here or as shown from the initial job setup.

- Select the **Area to Machine as Whole Relief.**

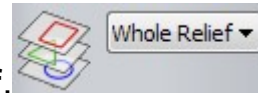

Note: Whole Relief defines the complete model page and not just the Relief itself. Machining can be restricted by using the alternative option of **Selected Vector**.

- Change the **Tolerance to 0.01**

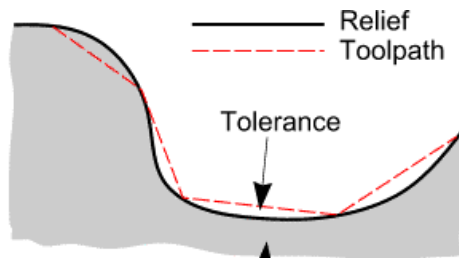

Tolerance determines how accurately a cutter path follows the true shape of the **relief**, the actual value being the maximum permissible deviation from the **relief** form.

- In **Finishing Options**, select  to launch the **Tool Database**.

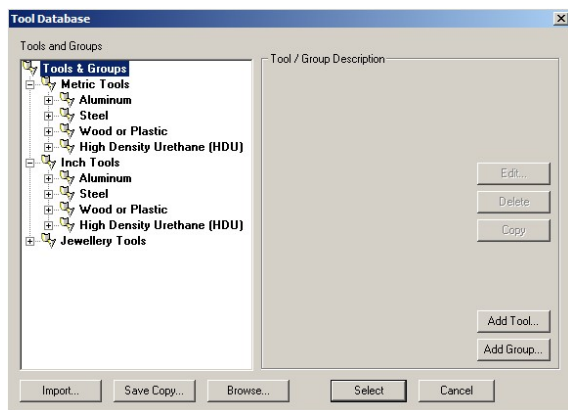

The default **Tool Database** contains a large selection of tools and associated parameters for a variety of materials. The selection can be modified, deleted, or added to by the user as required.

You can also have access to the **Tool Database**

by selecting the icon  in the **Toolpath Operations Tab**.

- By selecting the  sign next to the names, **Browse to Metric Tools > Aluminium > 3D Finishing >**

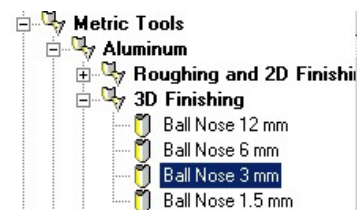

- **Select the Ball nose 3mm.**

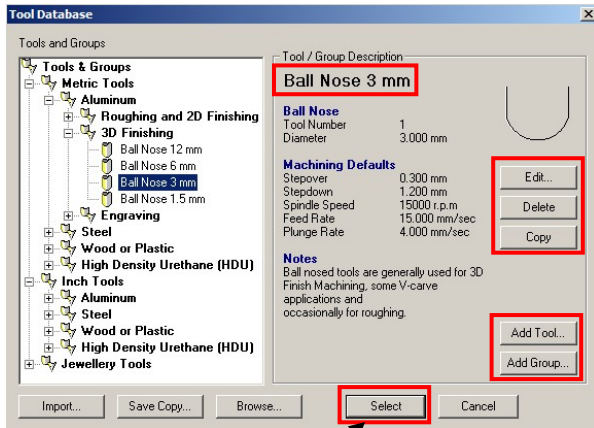

When a tool is **selected** (highlighted) in the left hand window, the tool data and description is displayed on the right-hand side of the form.

Individual tools can be **Edited, Deleted or Copied**.

New Groups and Tools can also be created for **customisation**.

- **Press Select on the form to accept the 3mm Ball Nose as the finishing operation tool.**

The **3mm Ball nose tool** and its parameters are now **loaded** into the **Machine Relief form**.

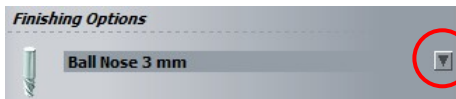

- **Select the down arrow**  **to reveal the default settings for the selected tool.**

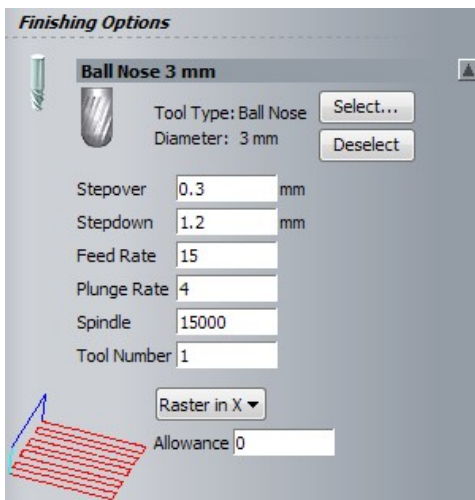

The **default tool parameters** (for Aluminium 3mm Ball Nose) are shown. Changing values in this form do no affect the original tool stored in the database.

The **Stepover** is the distance between passes.

The **Stepdown** is the incremental depth of cut (slices).

A **Tool number** is essential if outputting to a machine tool fitted with an automatic tool changer.

- Change the **Stepover** to **0.5mm**.
- Leave the **Stepdown** as the **default 1.2mm**.
- Ensure the **Raster in X** strategy is selected
- Ensure the **Allowance** is set to **0mm**.

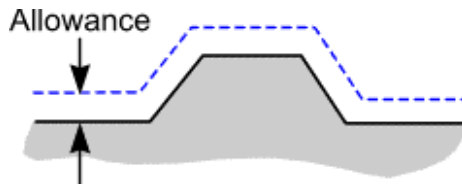

The **Material Allowance** is the specified thickness of material that is left on over the actual **relief** when the toolpath is created.

So based on the above value of **0mm**, no material will remain on the relief after machining has completed.

The **Roughing Tool** (first operation) will now be defined.

Roughing will remove the excess material from around the **Relief** up to the specified **Material Allowance** and **Tolerance** values. For efficiency, a relatively large tool is generally used for this operation. **Roughing** splits the **Material** into **Z Slices** and performs the selected **Area Clearance** strategy (**Raster** or **Offset**) on each one.

- In **Roughing Options**, select  to launch the **Tool Database**.

- Browse **Metric tools**, **Aluminium**, **Roughing and 2D Finishing** and then select **End Mill 6mm**.

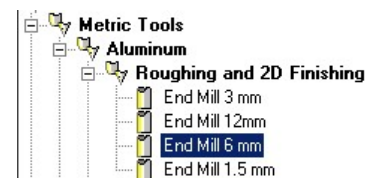

- **Select** the tool.
- Select the down arrow  on the **End Mill 6mm** bar.

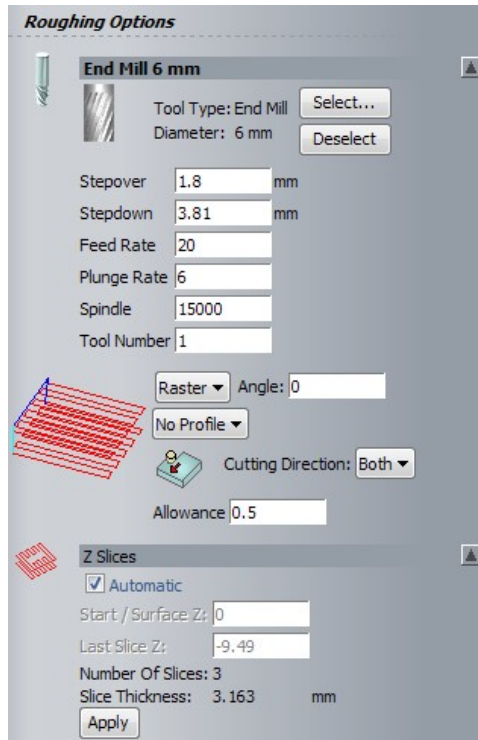

As before, the **Feed Rate**, **Plunge Rate** and **Spindle Speed** are based on the tool manufacturer recommendations but can be adjusted to suit the machine tool, and material used and how rigidly it is clamped down.

A unique **Tool Number** value must be input if the **toolpath** is for a machine tool with an automatic tool changer. If not, the value can be left as **1**.

- Change the **Stepover** to **4mm**.
- Change the **Stepdown** to **2mm** (this will be used for calculating the **Z Slices**).
- As before, leave the **default Feed Rate** at **20mm/sec**, **Plunge Rate** at **6mm/sec**, **Spindle** at **15000 r.p.m**, and **Tool Number** as **1**.
- Select **Apply** in the Z slices area

On clicking the **Apply** the number of **Z slices** (depth of each cut) is automatically calculated. The automatic figure of **5 slices** each at **1.898mm**, was calculated from the tool **Stepdown** (set as 2mm), Distance to bottom offset and Allowance.

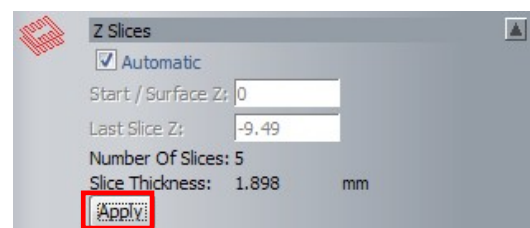

Start/Surface Z at **0** (this is the initial height from where the first **Step Down** value will be subtracted).

The **Last Slice Z** at **-9.49** defaults to the height of the **Material Allowance** above **Relief** base level. This value can be modified upwards to leave more material on the base level if required.

These values can be customised to suit (e.g if a thicker base is required) by altering the **Tool Stepdown value**, **Material thickness**, or by **unticking** the **Automatic** box and entering suitable settings.

- **Leave the values** as calculated automatically.

The next stage is to select a suitable **Strategy** from either **Raster** or **Offset**.

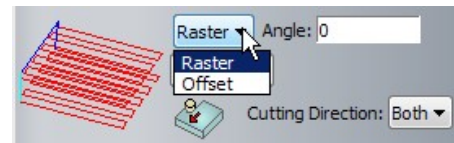

Raster Roughing



With the **Raster** strategy, the tool moves across the **Z Slices** in parallel, straight line moves separated by the **Stepover** distance. The toolpath is automatically limited away from the relief by the **tool radius** plus the **Material Allowance**, as shown.



The **Raster** process on its own tends to leave steps around the **Relief**. If required these can be removed by applying a **Profile Pass** either before (**First**) or after (**Last**) the **Raster** moves.

Offset Roughing



With the **Offset** strategy, the tool moves are offset inwards from the shape of the **Complete Relief** or limiting **Vector**, and outwards from the shape of the **Relief** contour. Individual tracks are separated by the **Step over** distance.

- Ensure the **Raster strategy** is selected with an **angle of 0 degrees**.

Selecting a profile will Add a profile 'clean up' pass either before, during or after each Z slice is machined. In this example the **Z Slices** will be machined using a **Raster** strategy without the addition of a **Profile Pass**.

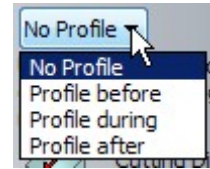

- **Do not select a Profile Pass.**

The default **Angle: 0** (along **X**) for the **Raster** strategy can be changed if required.

The **Cutting direction** of the tool can be selected here from either **Conventional** or **Climb Milling**.

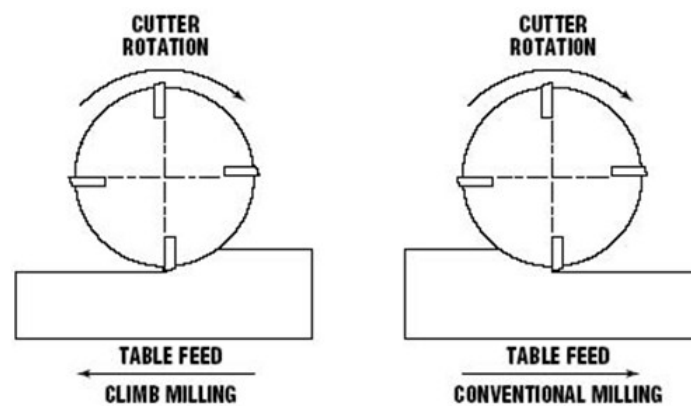

In **Conventional Milling**, the teeth of the tool meet the block of material at the bottom of the block. With this action, the teeth of the tool slide along until sufficient pressure builds up to break through the material surface.

In **Climb Milling**, the teeth of the tool meet the block of material of material at the top of the cut, at the thickest part of the cut.

Climb milling often provides a better finish, permits greater tool feed rates and prolongs the life of the tool.

- Leave the **cutting direction** as **both**.
- Ensure the **Allowance** is **0.5mm**.

This will leave **0.5mm of material** after machining. The finishing tool will then remove this allowance down to zero for the final finishing strategy.

- Leave **Add Ramping Moves** unticked.

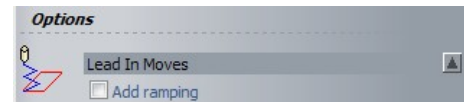

Ramping Moves are applied to avoid plunging, especially where harder materials are being machined. If **Add Ramping Moves** the user has access to a selection of ramping options to control the **Angle**, **Length**, and incremental **Height** of ramp moves.

- Select the down arrow  on the **Machine Safe Z** and Home bar.
- Set **Safe Z** at **15** and the **Home Position** as **X0 Y0 Z15**.

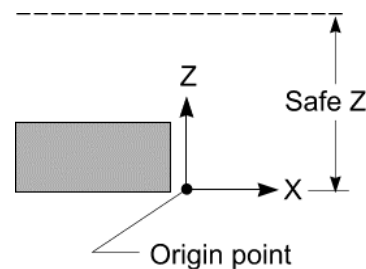
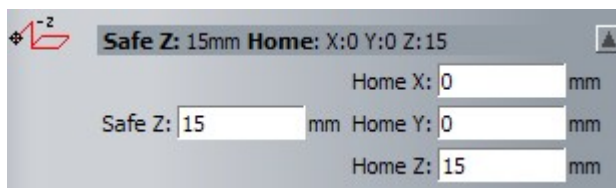

Safe Z is the user defined height in Z above the material where the tool can safely perform rapid moves to and from plunge positions.

Note: do not forget to consider the heights of clamping and fixture components, if applicable. The tool **Home Position** defines the **Start** (1st move) and **End** (last move) of the **toolpath**. It is not permitted for the selected **Z** value that is less than the **Safe Z** value.

- The **Material** has already been defined hence there is no need to open **Setup**.
- Enter the **name** for the Toolpath as **Relief Machining**.
- Select **Calculate Now** to commence the toolpath calculation.

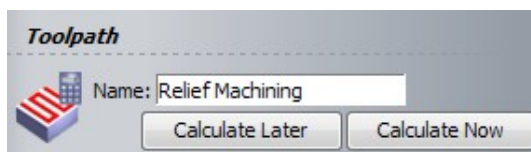

The **Toolpath** can be calculated **Now** or **Later**. When the option **Later** is chosen it will save the uncalculated toolpath until the **Batch Calculate** option is selected from the toolpaths menu.

Several unprocessed **Toolpaths** could be **Batched** ready to be calculated at a later time.

During calculation, a progress bar will show the current percentage completed.

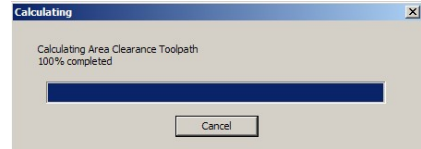

- Upon completion, **close** the machine Relief form

The 3D view, illustrates the calculated cutter paths.

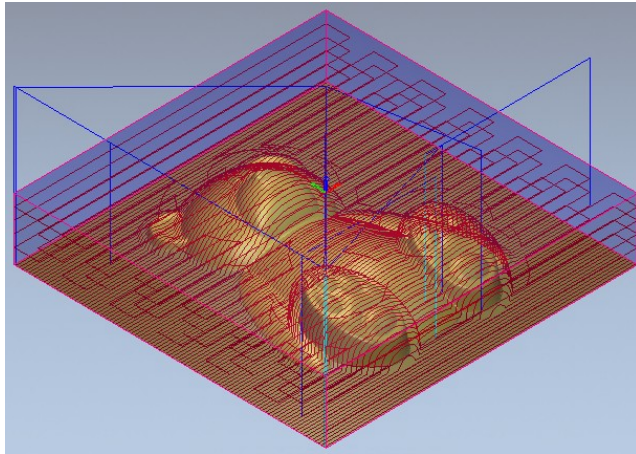

The generated **Toolpath** components are colour coded to assist with both visualisation and identification for **post-processing**.

Cutting **Feed Rate** moves are **Red**, **Safe Z** rapid moves are **Dark Blue**, and **Plunge/Ramp** moves are **Pale Blue**.

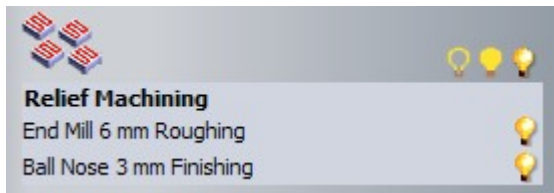

The **Toolpath** appears at the top of the **Toolpaths** page. The **Toolpath** can be shown or hidden by selecting the relevant bulb icons.

The **Objects to Draw** icon  at the top of the **3D View**, allows the user to toggle the visibility of all entity types (not just machining toolpaths).

- Click **Objects To Draw**  on the **3D View** Toolbar.

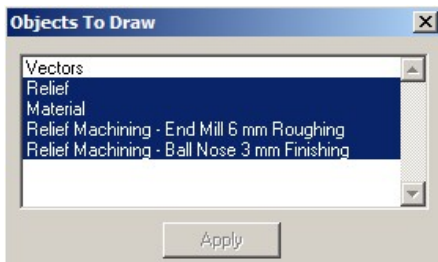

You can toggle between different objects by clicking on them and by selecting **Apply** to display the selected items in the **3D View**. Currently, only the Vectors are undrawn.

- Highlight **only** the **End Mill 6mm Roughing** toolpath and select **Apply**.

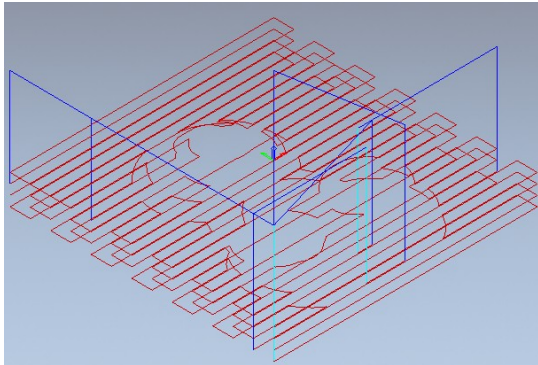

The Initial **Roughing Toolpath** is now the only displayed item.

- Highlight **only** the **Ball Nose 3mm Finishing** toolpath and select **Apply**.

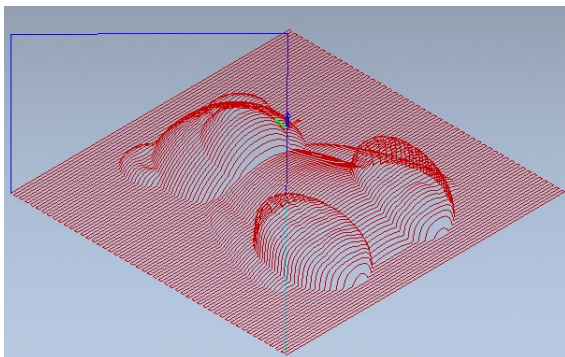

The **Finishing Toolpath** is now displayed.

- Highlight all objects as before, followed by **Apply**.
- Select **File** and then **Save**.

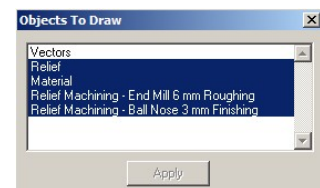

The **Toolpaths** have been saved into the current **ArtCAM** model.

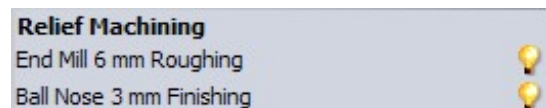

If the Toolpaths require **Editing**, **double left mouse clicking** on the toolpath in the Toolpaths window will reopen the **Machine Relief** form.

Any parameter can be **changed** and **recalculated** to update. **Note:** if a new, separate **Toolpath** is required, edit the **Name** to be different from the original.

Certain parameters can also be quickly changed by highlighting the individual toolpath and then selecting **Toolpath Parameters** at the bottom of the **Toolpaths fly out menu**. Select **Apply** to update.

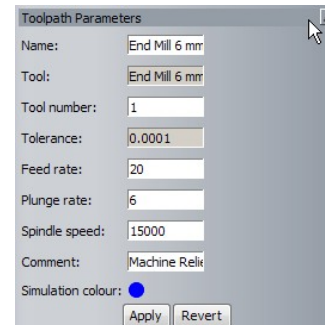

Simulating the Toolpaths

Toolpath movement and material removal can be **simulated** in the **ArtCAM 3D View**. Options are available in the **Toolpath Simulation Tab** at the bottom of the **Toolpaths fly out menu**.

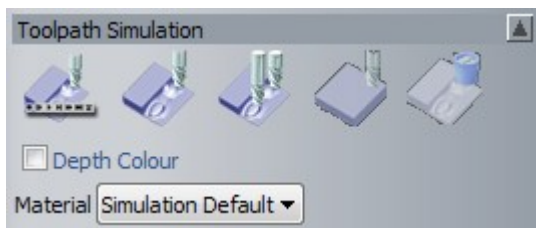

Options available in this menu are **simulate, reset, delete, export and import the simulation**.

The shading can also be changed to reflect the final material.

- Select and **Highlight** the **Relief Machining Toolpath**.

If **Simulate Toolpath** is selected,  all individual Toolpaths (within the Toolpath) will be simulated in sequence.

- Select **Simulate Toolpath**. 

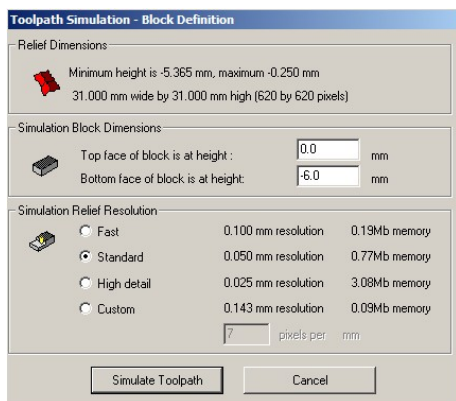

The following form will be displayed:

Relief Dimensions: shows the overall dimensions of the relief.
Simulation Block Dimensions: gives the size of the block. This should be at least as big as the minimum and maximum height of the relief plus any height (or depth) of the engraving features.
Simulation Relief Resolution: specifies the quality of the image that you require. The lower the resolution, the greater the speed of calculation.

- Select **Standard** from the **Simulation Relief Resolution** area.
- Use the other default settings and select **Simulate Toolpath**.

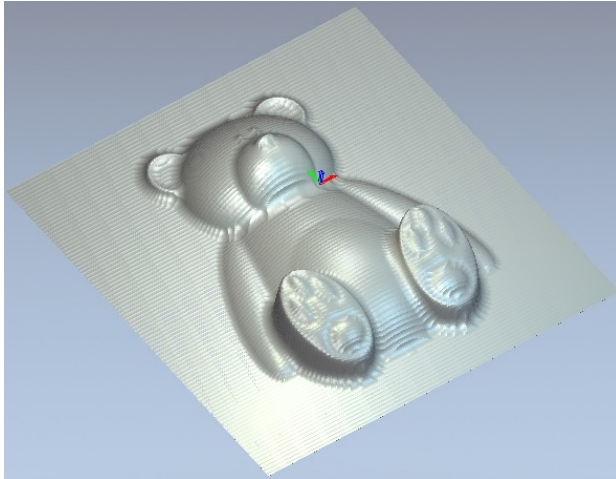

The two toolpaths in the sequence listed are simulated on screen and the final result shown (after finishing operation)

- Select **Reset Simulation** to reset the block.



The toolpaths will be simulated individually to verify the results after each stage.

- Select and **Highlight** the **Machine Relief** Toolpath.

- Select **Simulation Control bar**.

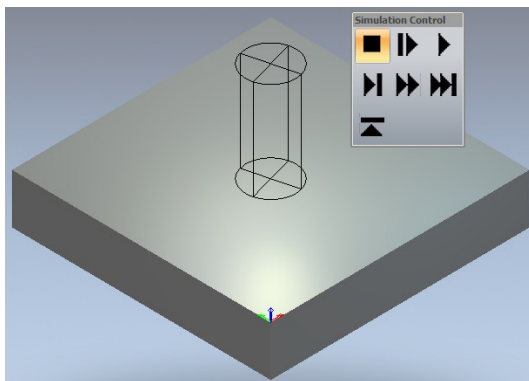

With this option the highlighted tool is drawn (End Mill 6mm first), along with a control panel to control the speed of the simulation.

For example, Selecting  will simulate at normal cutting speed.

- In this case, select **Run at Max speed to next retract**.



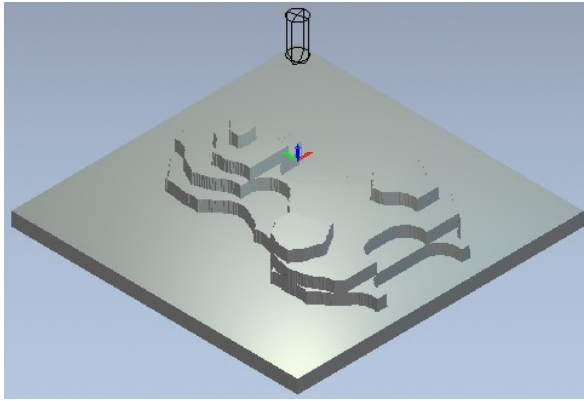

The simulation stops (and retracts) at the end of the first Toolpath **End Mill 6mm Roughing**.

- Select **Run at Max speed to next retract**  again.

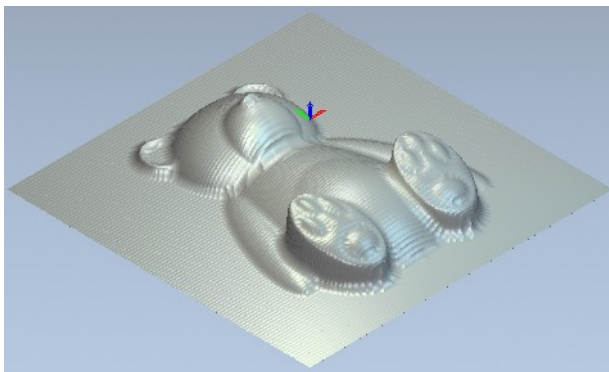

The simulation ends at the final toolpath **Ball Nose 3mm Finishing**.

The result is a 3D model of the part machined component which also within graphics limitations will indicate the standard of surface finish.

The calculated toolpaths are ready to be post processed (saved). This is explained in the next chapter.

8. Post Processing Toolpaths

Introduction

The **Toolpaths** produced in **ArtCAM** have to be translated into a different format as an exported file for a specific **machine tool controller**. The collective name for one of these files is **NC data** and the operation is called **Post-Processing** which is accessed via the **Save**

Toolpaths option in the Toolpaths Tab.



Post Processing of Toolpaths for a Manual Tool Changer

- Open the previously machined model. **training-savannah.art**
D:\users\training\COURSEWORK\ArtCAMPro-Jobs.
- **Activate the Toolpaths fly out panel** if not already visible.

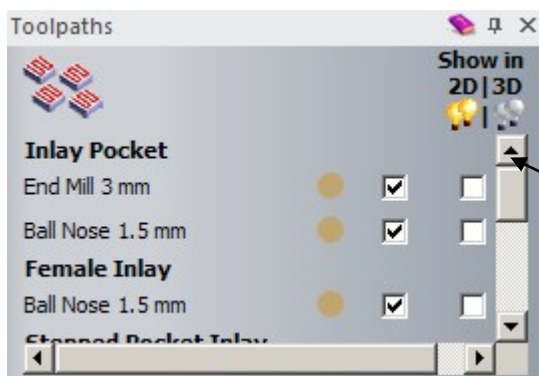

All toolpaths previously calculated are listed.

Use the scroll bar to view all.

- **Select Save Toolpaths**  from the **Toolpath Operations** area.

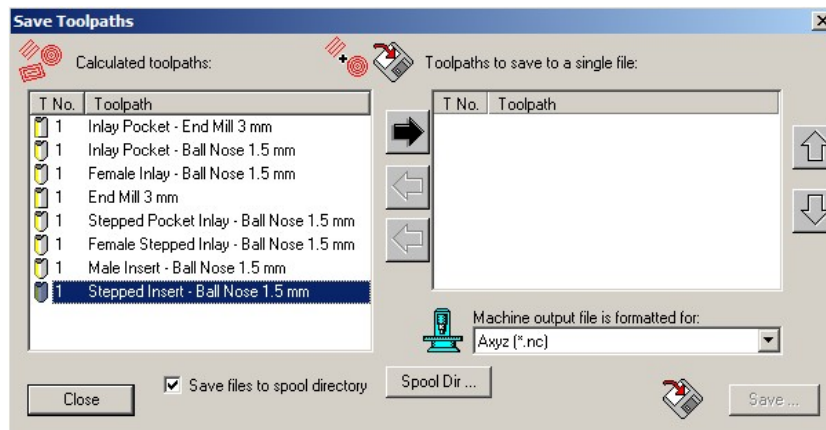

When the **Save Toolpaths** form is opened all existing toolpaths are listed in the **left hand window**. **Toolpaths** are selected and transferred from one side to the other using the central **Arrow** buttons.



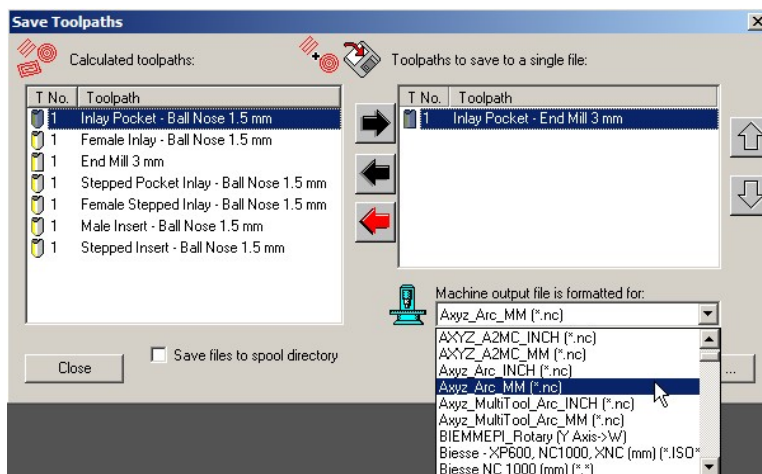

All the files in the **right hand window** will be included for output into a single **NC data** file. If the machine tool uses a **manual tool changer** then it will only be possible to include **Toolpaths** in the **NCdata** file that share the same cutting tool. If the machine tool has an **automatic tool changer** then any combination of the available **toolpaths** can be include in the **NCdata** file. (as long as the selected machine supports it)

- **Select the toolpath Inlay Pocket – End Mill 3mm** and then the **right Black arrow**.  (to transfer it across)
- Deselect **Save files to spool Directory** (You will be prompted for the location directory for outputting the current **NCdata** file).
- From Machine Output, **select Axyz_Arc_MM(*.nc)**



Note: this machine does not support an **automatic tool changer** hence only **Toolpaths** that use the same **tool** can be included in the **ncdata** output file.

- Select **Save** and browse to select **C:\temp**, enter a **File name** as **Em3-Inlay Pocket -Savannah** and select **Save**.
- Select the **left black arrow**  (to move the toolpath back to the left window).
- Select the toolpath **Inlay Pocket End Mill 1.5mm** and then the right **Black arrow**. 
- Select **Save** and browse to select **C:\temp**, enter a **File name** as **Em1.5-Inlay Pocket -Savannah** and select **save**.
- **Repeat the above procedure** for the **remaining Toolpaths** providing suitable file names.
- **Browse to the C:\Temp directory to see the saves toolpaths.**

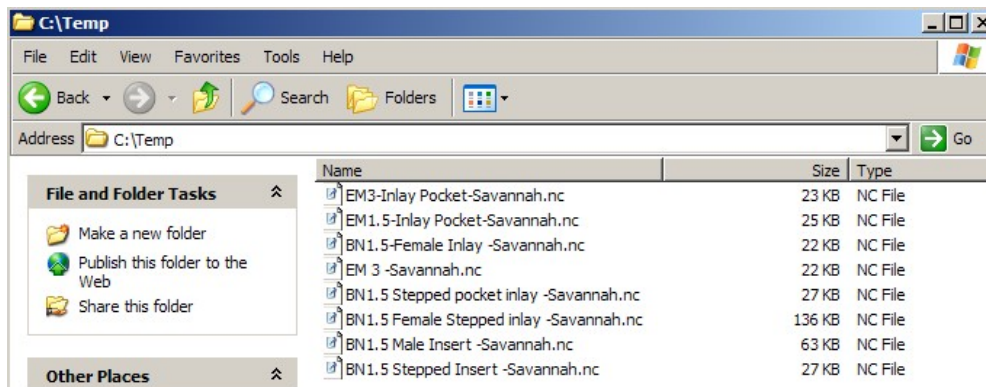

All the **post-processed Toolpaths** have been saved outside **ArtCAM** and translated in the format required for an **Axyz machine controller**. These files can now transferred to the machine controller itself, ready for manufacture.

Note: If the Toolpath is modified within ArtCAM, the above process must be repeated for that specific file.

- Do not **close** the model as it is required again in the next chapter.

Post Processing of Toolpaths for an Automatic Tool Changer

If a **Machine Tool** is fitted with an **Automatic Tool Changer** then the control of this feature will be available in the **Post Processor** translation.

If toolpaths containing different tools are passed over to the right hand window of the **Save Toolpaths** form and the selected **Post Processor** does not support an Automatic Tool Changer then a box with an error message will appear.

- Using the **black arrow**,  **Transfer all** the toolpaths into the right hand window as shown.

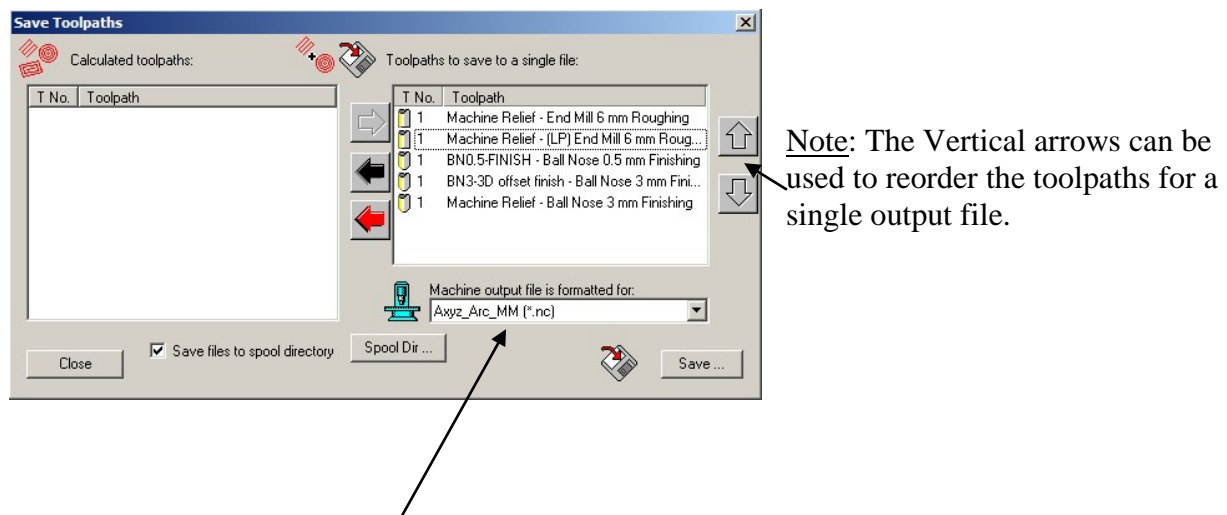

- Ensure the **same machine output file** is selected as before.
- Select **Save** to output the combined files.

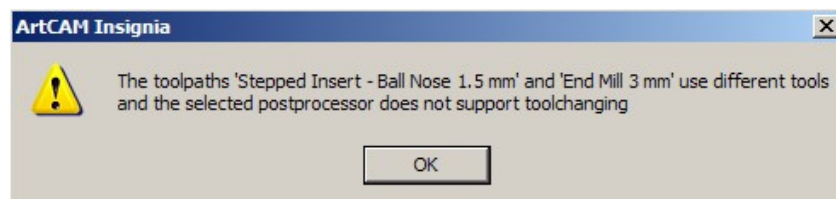

The operation has **failed and the above error message appears**. The files were unable to be processed for two reasons.

1. The selected Machine (post processor) **does not support** tool changing itself.
2. All tools are currently identified as Tool number 1. The **Tool Number** is essential to identify the location of an individual **Tool** in the **tool changer** or **carousel**



The Tool Number can be defined in a number of ways.

1. **Entering the tool number** within the defined tool of the toolpath. The Toolpath must be **recalculated**.

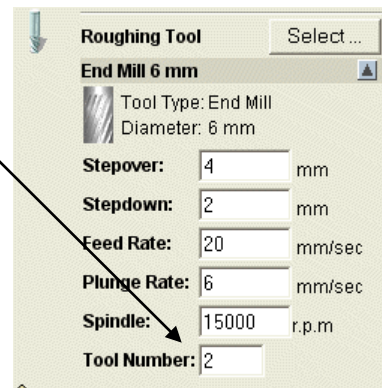

2. **Entering/Editing the default tool number** defined in the Tool database.

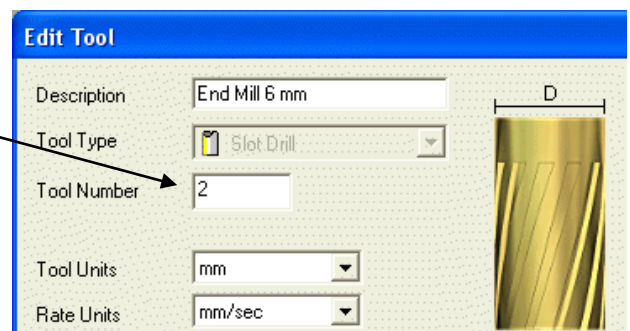

3. The simplest way is to change the tool number by first highlighting the tool in the Toolpaths Tab.

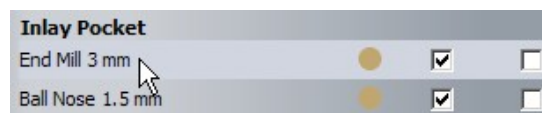

Expand  the **Toolpath parameters Tab** at the bottom of the **Toolpaths Panel**.

The **Tool number** can be changed here and updated by just selecting **Apply**.

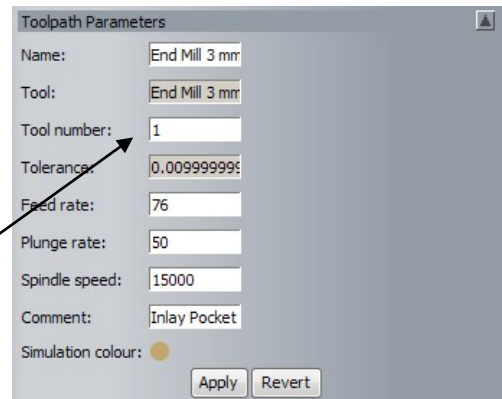

- Use **any** of the methods described above to assign **Tool numbers** as shown in the image below.

- Select **Save Toolpaths**  from the **Toolpath Operations** area.
- **Move** all the Toolpaths to the **right hand window**.
- **Reorder** the Toolpaths as **required to machine**.

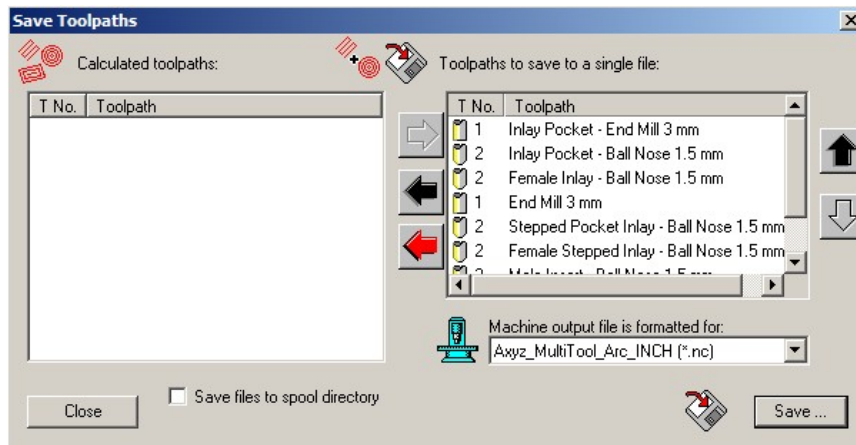

- **Change** the Machine output file to **Axyz_MultiTool_Arc_MM**.
- Select **Save**.

Note: No Error message is displayed and now allows the files to be saved as one.

- Locate **C:\temp** and enter the **File name** as **Savannah** and select **save**.

NC code can be viewed in WordPad for analysis or editing if required.

- **Browse** to the **C:\Temp** directory to see the saved toolpaths.
- **Right mouse click** on the Toolpath an **open with WordPad**.

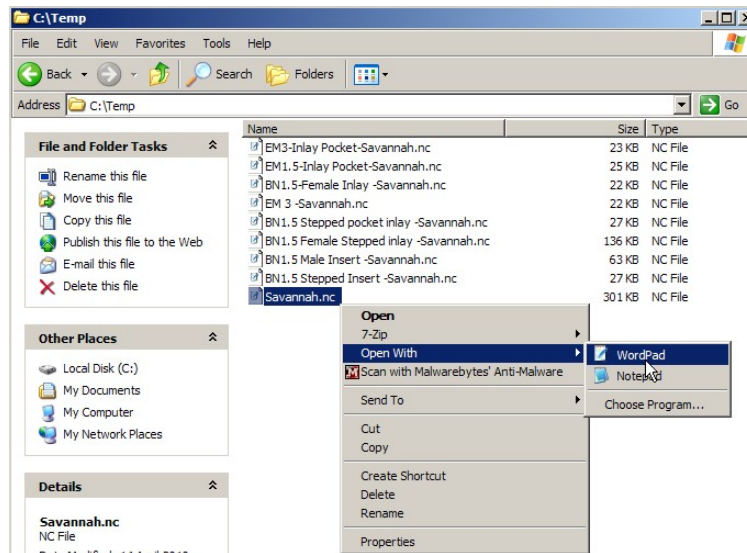

The outputted NC code can be viewed.

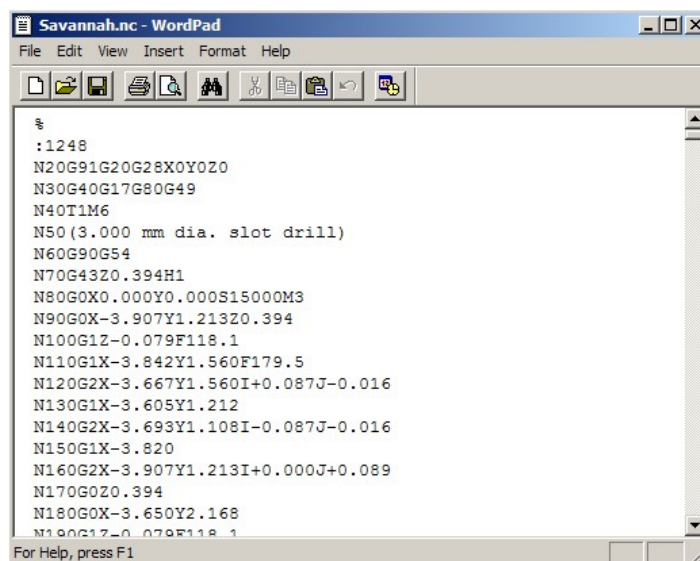

9. Engraving

Introduction

Smart Engraving allows you to input a selection of **Roughing (End Mill)** and **Engraving (V Shaped)** tools, which create a series of **efficient toolpaths within the defined vector selection** ultimately producing the required **engraved** form. Different machining parameters and tool settings can be applied to each **toolpath** from within the **Smart Engraving** options. For small detail it is possible to run **Smart Engraving** with one 'V' shaped tool.

If more than one tool is selected, Smart Machining is performed. This is the strategy where smaller tools will only machine the areas previous tools were unable to reach. If conical tools are used, options to enable 3D corner sharpening moves are available.

Smart Engraving Exercise

- Open the model **arch.art** from: **D:\users\training\ArtCAM Data**.

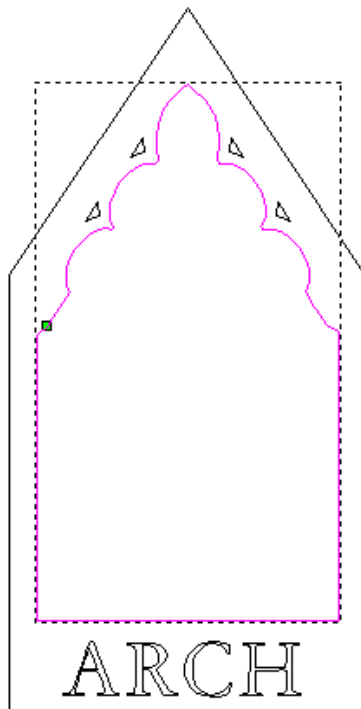

The **Smart Engraving** options provide for finishing of sharp internal corners for the finishing toolpaths using the 'V' Bit Cutters.

The **selected vector** is the top edge of the detail. The option to offset the **End Mill** for the **Engraving Tool** (it leaves additional material on) is used to give the **V-Bit finish tool** some material on each side to cut out, to balance the loading on the **V-Bit tool**.

- Select only the **Inner feature vector** as shown above.

- Select **Smart Engraving**  from the **2D Toolpaths Tab**.

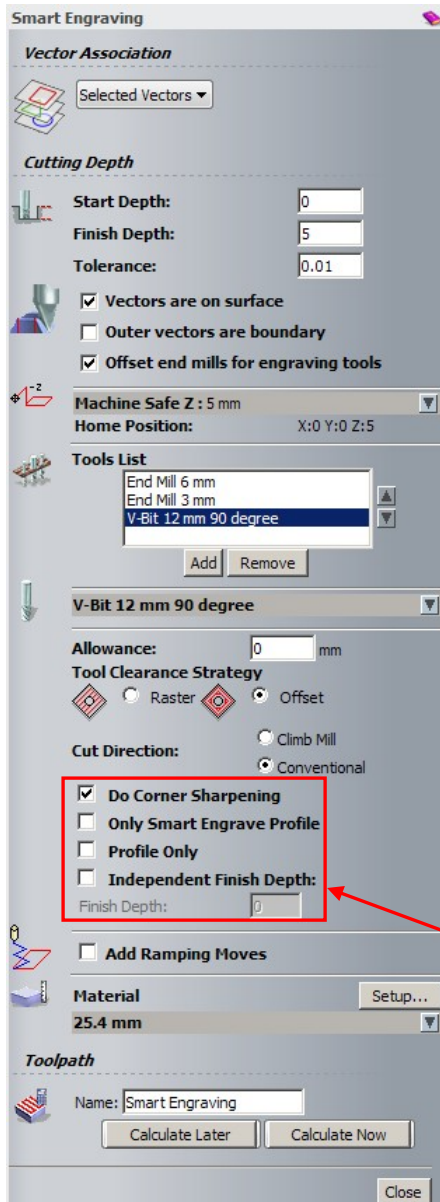

- Enter a **Start Depth of 0** and a **Finish Depth of 5mm** and **Tolerance as 0.01**.
- Select the option **Vectors are on surface**. This assumes the vectors lie at the **top of the surface**. **Unticking** the box assumes the vectors **lie at the bottom**.
- Select **Offset End mills for Engraving tools**.
The End Mill tool will be offset to ensure the engraving tool will be able to machine an angled wall.
- Set **Safe Z as 5** and **Home Position X0 Y0 Z5**.
- **Add a 6mm and 3mm End Mill tools**, along with a **Small V-Bit 12mm 90 Degree tool**.
Note: the V-Bit tool will have to be copied and edited within the Tool Database from an existing stored tool.
- Enter an **Allowance of 0.1mm** only on the **End Mill 6mm** tool.
Note: Several parameters can be defined independently for the specific **tool** selected (highlighted) in the form.
- Select **Do corner Sharpening** only for the **V-Bit 12mm 90 degree tool**.
- Set the **Material Thickness to 25.4mm** with the **Z0 origin at the top**.

The machining calculations will take the **vector** to be the top edge of the chamfered detail.

- For the **End Mill 6mm** tool set the tool **Stepover to 4mm** and the **Stepdown to 5mm**.
- For the **End Mill 3mm** tool set the tool **Stepover to 0.5mm** and the **Stepdown to 1mm**.
- For the **Small V-Bit 12mm 90degrees tool** set the tool **Stepover to 0.1mm** and the **Stepdown to 5mm**.

- Enter the Name **Smart Engraving**.
- Select **Calculate Now**.
- **Close the form**

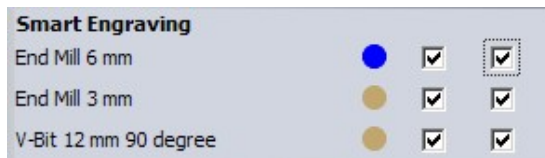

As always, The Toolpaths are listed in Toolpaths fly out panel.

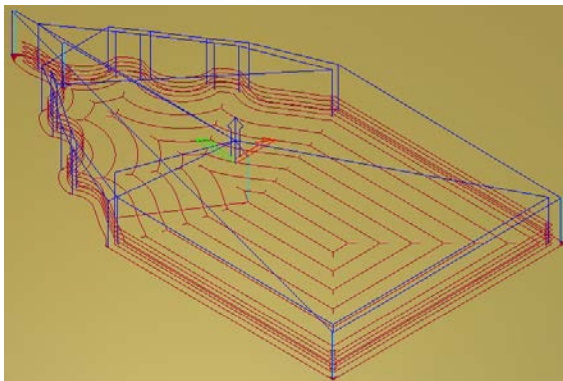

All of the 3 toolpaths created by the Smart Engraving options are displayed and could all be simulated at the same time. It would however be better to simulate them one at a time to see more clearly what each one is actually machining.

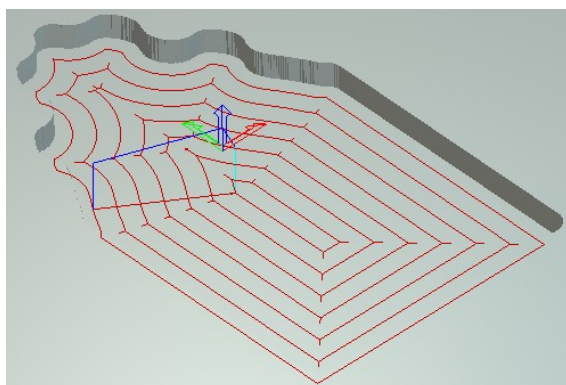

End Mill 6mm tool

This operation performs **Area Clearance** on the whole aperture to full depth (less than the **Stepdown** value).

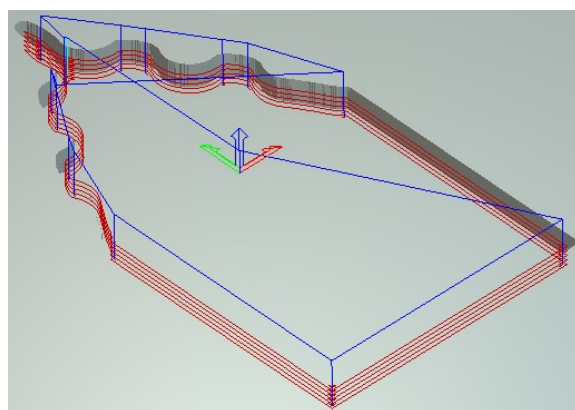

End Mill 3mm tool

This operation performs **Area Clearance** on areas inaccessible to the larger End Mill. In the small enclosure at the tip the **1mm stepdown** causes machining to occur at several **Z** descending **Levels**.

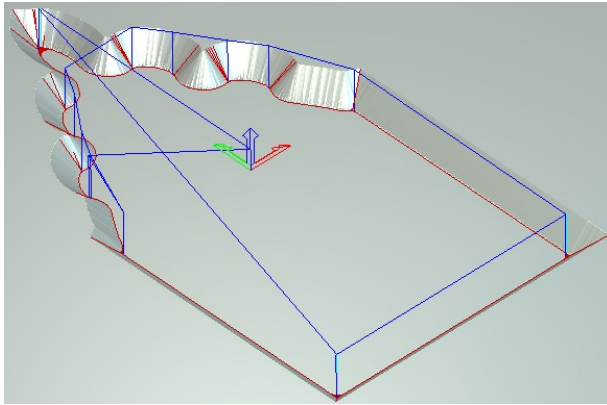

Small V-Bit 12mm 90degree tool
With **corner sharpening on**, the tool will ramp along internal corner intersections to produce the sharpened and completed shape.

- Select the 2D View and **select the four triangular vectors and the text arc.**

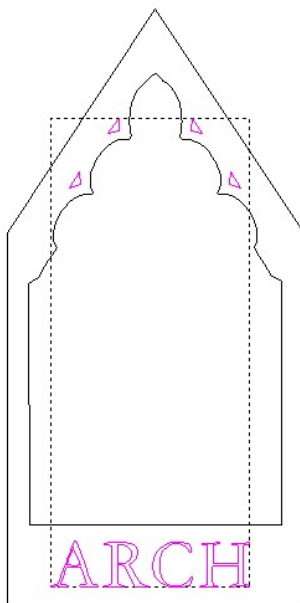

As these are only small indentations only one **V-Bit** tool will be required.

- Select **Smart Engraving**  from the **2D Toolpaths Tab**.
- Enter a **Start Depth of 0**, a **Finish Depth of 3mm** and a **Tolerance of 0.01mm**.
- Select the **Small V-Bit 6mm 90 degrees tool**.
- Change the **Stepdown to 3mm**.
- Select **Tool Clearance Strategy as Offset**.
- Select the option **Do Corner Sharpening**.
- Select **Calculate Now**, followed by **Close**.

Note: The name Smart Engraving 1 was automatically provided.

- Select **Simulate Toolpath**.

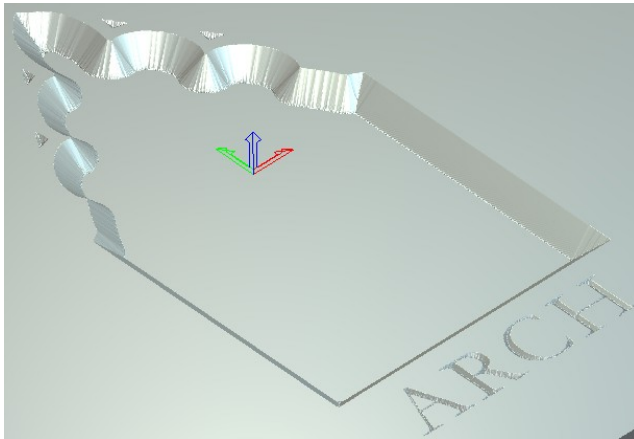

The small features and text have been machined using a single operation with the V-Bit tool.

Machine Along Vector

The **Profile Toolpath** option  also provides the option to directly trace along a **selected vector**, to a user defined depth. A typical application would to mark a **scribe line** around the outside of a component form.

- Select the **Outer vector** as shown below.

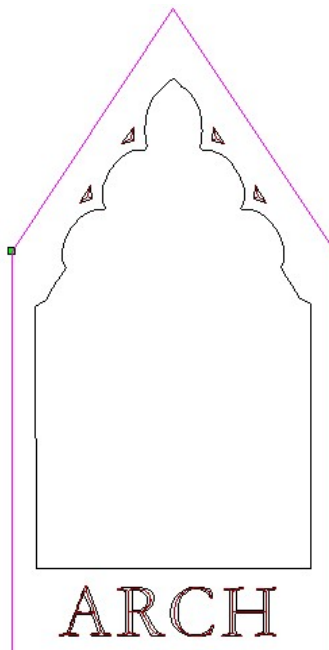

- Select **Create Profile Toolpath**  from the **2D Toolpaths Tab**.

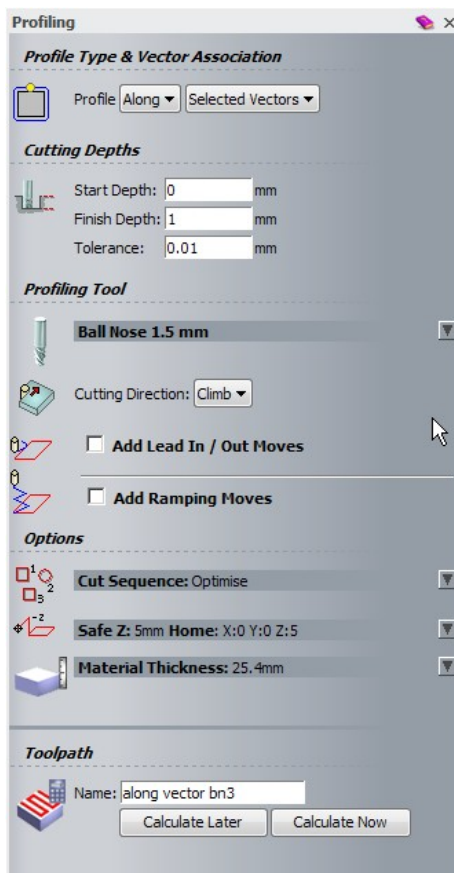

- Enter a **Finish Depth of 1mm**.
- Select a **Ball Nose 1.5 mm tool**.
- Enter a name **Along vector BN3**
- Select **Calculate Now**.
- **Close** the form.
- **Simulate** the toolpath

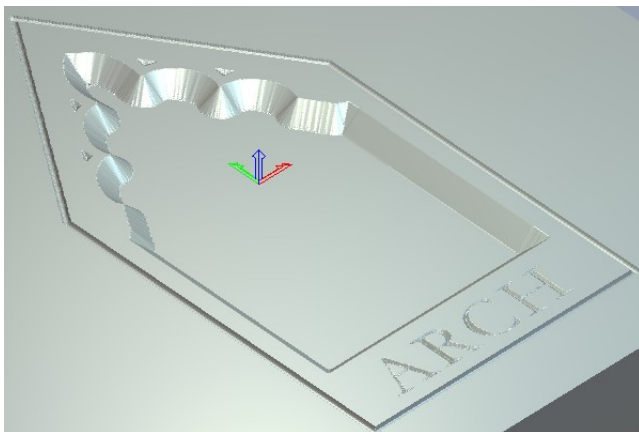

The **outer** limit of the component has been 'scribed' with the **1.5mm Ball Nosed tool**.

- Select **File - Save As** and enter as File Name **SmartEngraving.art** in: **D:\users\training\COURSEWORK\ArtCAMPro-Jobs**.
- Select **File – Close Model**.

10. Drilling

Introduction

In the **2D Toolpaths** section there is a **Drilling** option, which uses selected **vectors** for defining the **hole** positions. The hole positions are defined either **Central to circle vectors**, at **vector Node points**, at a **vector dimensional Centre**, or on the **Plunge Move** positions of a **selected 2D Toolpath**.

For creating a **Drill tool** the **V-Bit tool page** is used as this has the same geometrical shape.

- Open the model **Drilling.art** from: **D:\users\training\ArtCAM Data**.

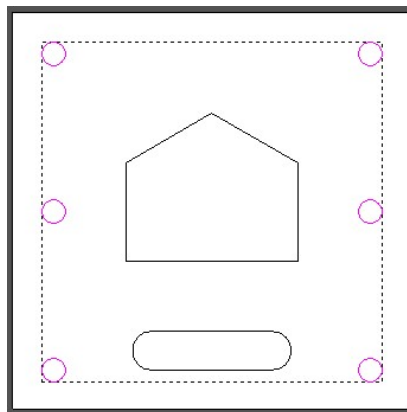

- Select the **6 Circle vectors**.
- Select **Create Drilling Toolpath**  from the **2D Toolpaths Tab**.

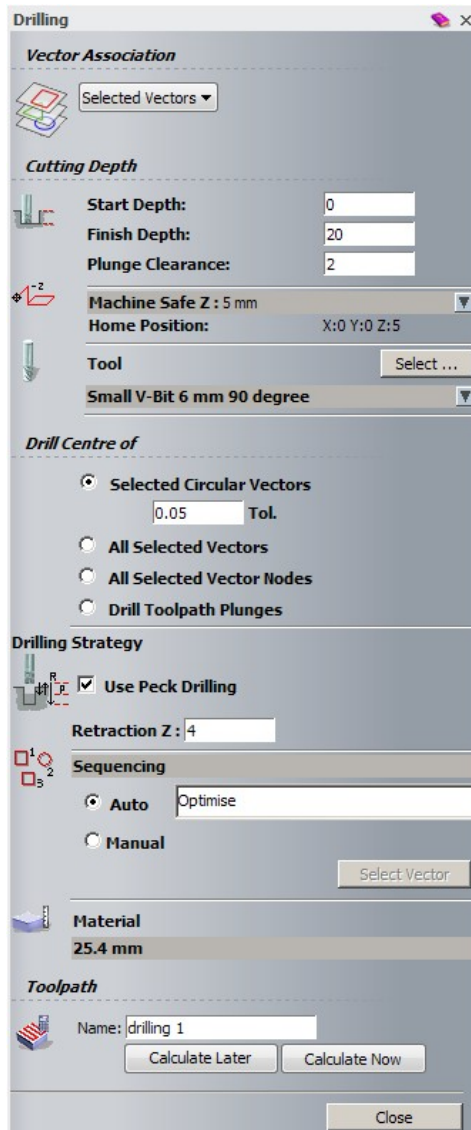

- Enter a **Start Depth of 0**, a **Finish Depth of 20mm** and a **Plunge Clearance of 2mm**.

Plunge Clearance is a separate **Safe Z** for **Drilling**.

- Set a **Safe Z of 5mm** and a **Home Position of X0 Y0 Z5**.
- Select a **Small V-Bit 6mm 90 degree tool**.
- Change the **Tool Stepdown** to **6mm**.

- Select the option **Selected Circular Vectors**.

- Select **Use Peck Drilling** and enter a **Retraction value of 4mm**.

The **Drill** will lift **4mm** at each **incremental Stepdown** depth of **6mm**.

Optimise is one of several options controlling the order in which a **hole pattern** is **Drilled**.

- Define a **Material Thickness of 25.4mm** and set **Z Zero at the top**.
- Enter Name as **Name Drilling-1**.
- Select **Calculate Now**.
- Select **Close**.

- Select **Simulate Toolpath**.

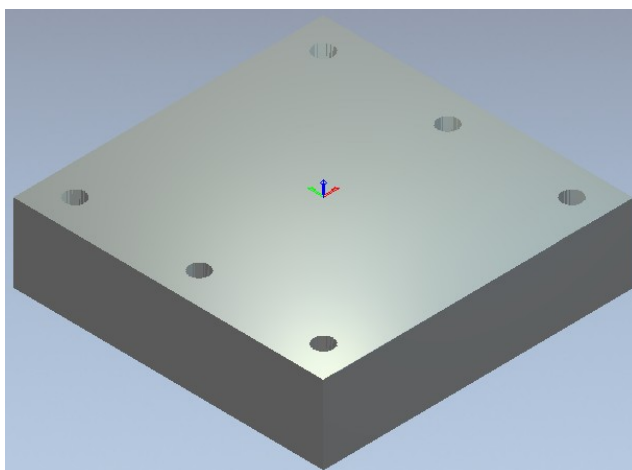

Note: To observe the **4mm** upward **Pecking** movements at **6mm** **incremental depths**, simulate at normal speed.



The **Drill Centre of... All Selected Vectors** will now be demonstrated. The **drilled hole** will be positioned dimensionally central to the **selected vector**.

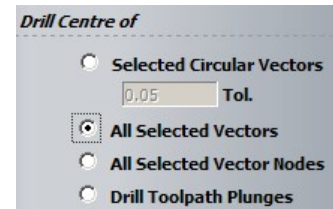

- In the **2D View** select the oval **vector**.

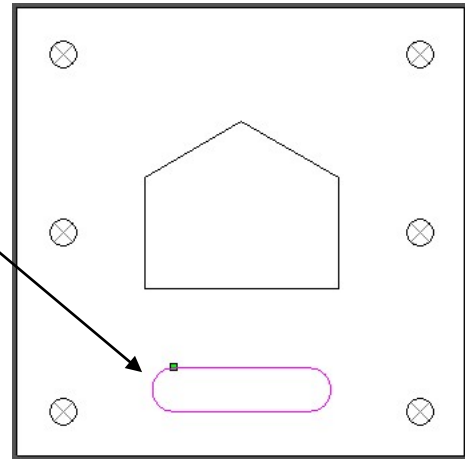

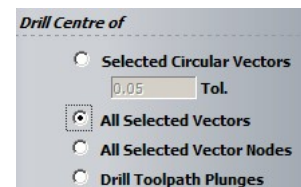

- Select **Create Drilling Toolpath**  from the **2D Toolpaths Tab**.
- Enter a **Start Depth of 0, Finish Depth of 6mm** and a **Plunge Clearance of 2mm**.
- Use the same **Small V-Bit 6mm 90 degree tool**.
- Change the **Tool Stepdown to 6mm**.
This means the drilling will be performed in a single peck.

- Define **Drill Centre of ... as All Selected Vectors**.
- Enter as Name - **Drilling-2**.
- Select **Calculate Now**.
- **Close the form**.

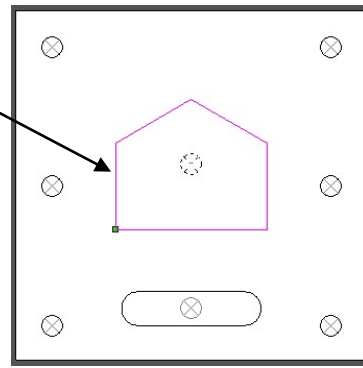

- In the **2D View** select the **5 Sided vector**.



- Select **Create Drilling Toolpath**  from the **2D Toolpaths Tab**.
- Enter a **Start Depth of 0**, a **Finish Depth of 10** and a **Plunge Clearance of 2mm**.
- Use the same **Small V-Bit 6mm 90 degree tool**.
- Define **Drill Centre of...** as **All Selected Vector Nodes**.

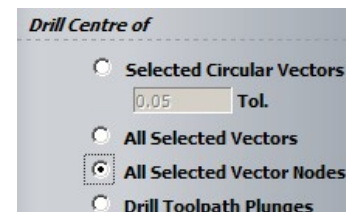

- Enter as Name - **Drilling-3**.
- Select **Calculate Now**.
- **Close** the form.

- Simulate the **Toolpath**.

Observe the drill plunge directly to the full depth of 10mm, at the Node points of the 5 sided vector.

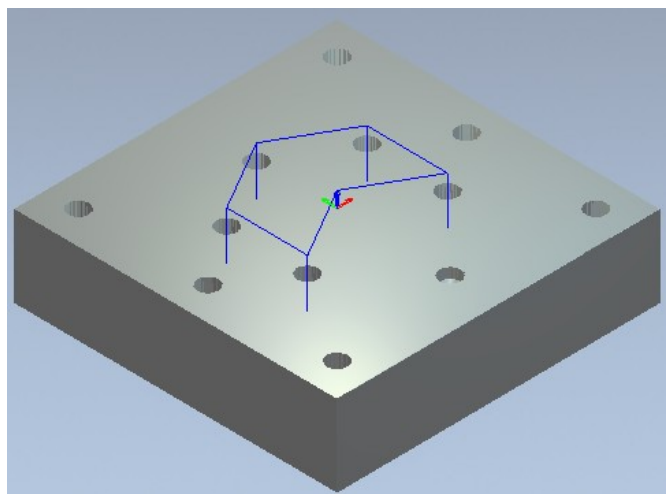

- Select **File - Save As** and enter a File name as **Drilling Example** in: `D:\users\training\COURSEWORK\ArtCAMPro-Jobs`.
- Select **File - Close Model**.

11. Toolpath Templates

Toolpath Templates

A **Toolpath Template** is a file containing one or more unprocessed machining strategies stored outside **ArtCAM** as a **.tpl** file. A previously stored **Toolpath Template** is imported into **ArtCAM** and the associated **machining strategies** can be then edited (if required) before the **toolpaths** are regenerated for the current **model**.

The benefit of **Toolpath Templates** is that a whole set of unprocessed machining strategies can later be loaded into **ArtCAM** with all the **tooling** and **settings** already set for the user specific application or for a series of similar **ArtCAM** models.

- Open the model **train-breadbin-lid.art** from: D:\users\training\ArtCAM Data.
- **Activate the Toolpaths fly out panel** if not already visible.

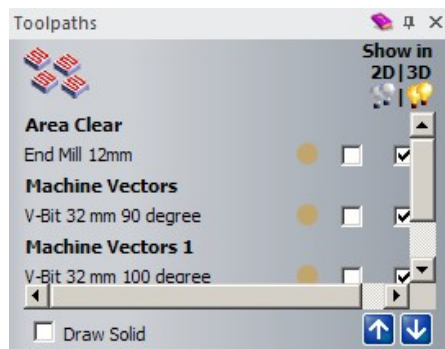

This **ArtCAM** model contains **four Toolpaths**, one of which requires a closed **vector** to control the area to be machined. When a **Template** is **Saved/Created**, all **toolpaths** that exist in the model are included in the output file.

- Select **Save Toolpath as Template**  from the **Toolpath Operations** area.

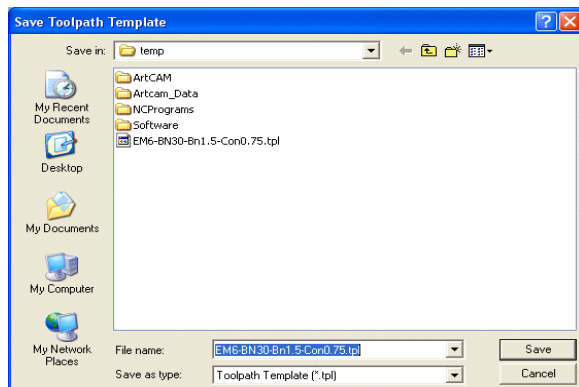

The toolpath template is a special file type (*.tpl) and is stored outside of the **ArtCAM** model.

It is a good idea to be as descriptive as possible with the template name.

- Select the area **D:\users\training\COURSEWORK\ArtCAMPro-Jobs** and enter the **File name EM12-VBIT32-90-EM12.tpl**.

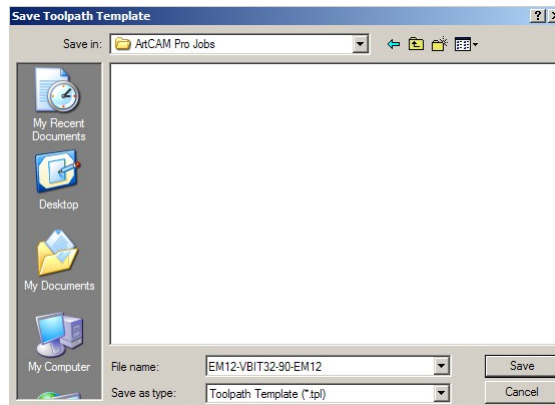

- Select **Save**.

The template can now be loaded into a different model or, if these toolpaths have been deleted, they can be loaded back into the current model.

- In the current model, Select each **toolpath** and delete it using **Delete Toolpath**  in **Toolpath Operations**.



(It therefore assumes at this point, the Relief has just been created.....)

- From **Toolpath Operations**, Select **Load Toolpath Template**. 
- **Browse and Select** the previously created file **EM12-VBIT32-90-EM12.tpl**
- Select **Open**.



The Unprocessed **toolpaths** are displayed in the Toolpaths Tab. In addition, there are no '**display toolpath**' tick boxes below '**Show in 2D|3D**' indicating that they have not yet been calculated.



- From **Toolpath Operations**, Select **Batch Calculate Toolpaths**.

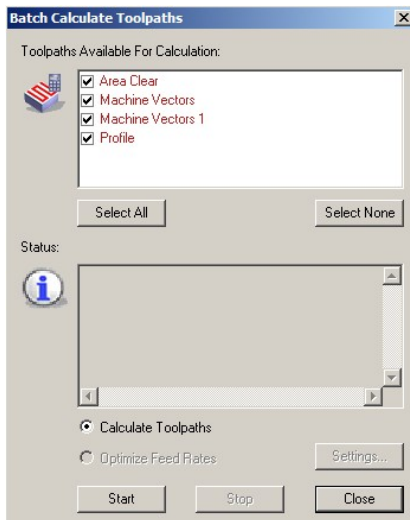

The form appears with all of the **toolpaths** listed. By default all of the toolpaths are ticked, ready to be included in the **Batch Calculate** process.

Note: If use a **selected vector** is specified in the **toolpath** page, a suitable **vector** must first be created and selected if **Batch Calculating** the **template** on a different model.

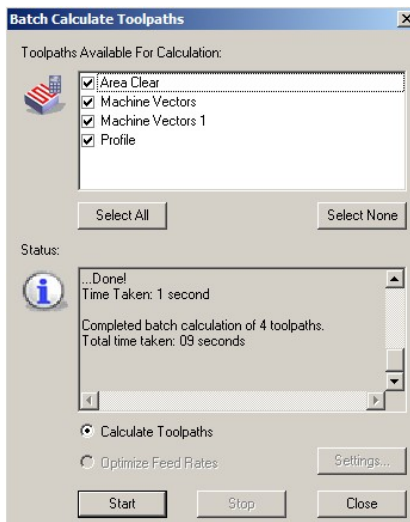

- Select the **Start** tab to commence calculation of the toolpaths.

- **Close** the dialog box when finished.

All of the **toolpaths** have been calculated including the selection of a suitable limiting **vector**. As the **Toolpath Template** is being applied to the same model then the **vectors** will be remembered and selected automatically. If the **Toolpath Template** is applied to a different **model** then these **toolpaths** will have to be opened on an individual basis and suitable limiting **vectors** created and selected before **applying Calculate Now**.





- **Simulate All Toolpaths**.
- Select **File Save** and then **Close**.

12. Machining Inlays

Inlays

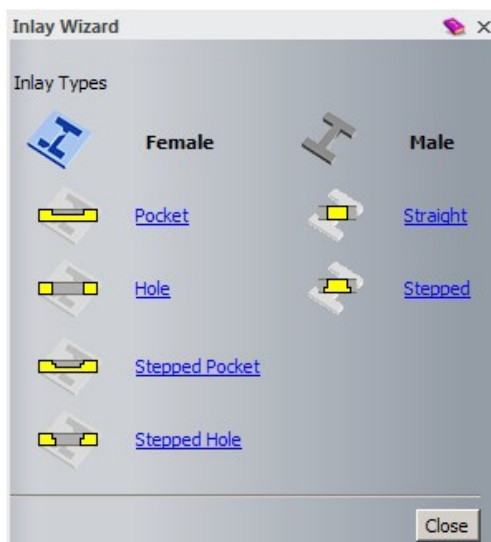
An **Inlay** is **text** or **vectors** with depth that is machined out of the material. The **Inlays** are usually machined in pairs using the same tool, so the male inlay will fit inside the female pocket or hole inlay.





The **Inlay Wizard**  creates the selected type of **Inlay** from the selected vector.

There are four female inlay options and two male options. The male inlay will fit inside the female inlay if an identical vector and identical tool is chosen.

Inlay Exercise

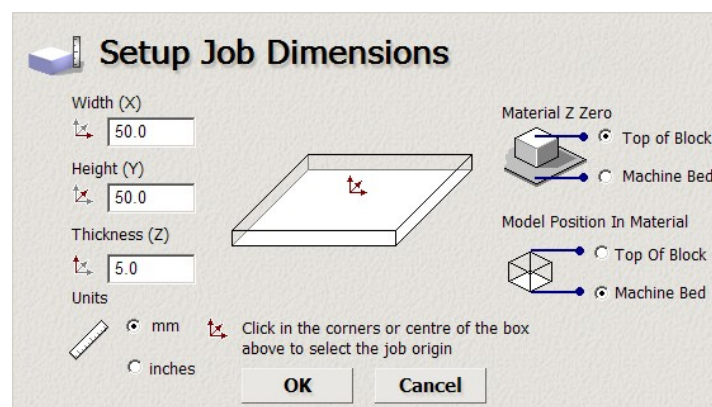

- Create a **New Model** of **Width and Height of 50mm** and a **Thickness of 5mm**.
- Select the **Origin in the Centre** and remaining options as shown below.

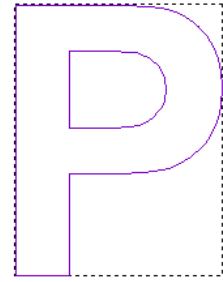

- Create a **Vector Text**  of the letter 'P' using **Arial, Western** and a **size of 25mm**.
- Position the text in the **middle** of the model (shortcut F9 to centre in page).
- Ensure it is **selected**.



A **Male** and a **Female Inlay** toolpath will be calculated.

- From the **2D Toolpaths** page, select **Inlay**. 
- In the **Inlay Wizard** page, select **Female Pocket**. 
- Enter the values and select the tools exactly as shown on the image below.

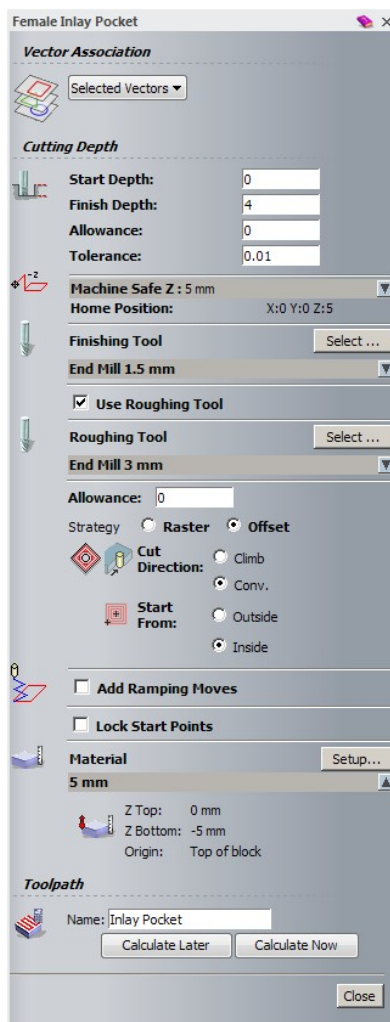

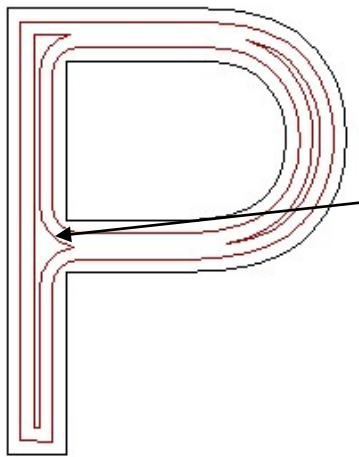

- Enter a **Finish Depth** of **4mm**.
- Set a **Safe Z** and **Home Z** of **5mm**.
- **Locate** and Select any **End Mill of 1.5mm** for the **Finishing Tool**.
- **Locate** and Select any **End Mill of 3mm** for the **Roughing Tool**
- Leave other options as shown
- Enter a name **Inlay Pocket** and then select **Calculate Now**.

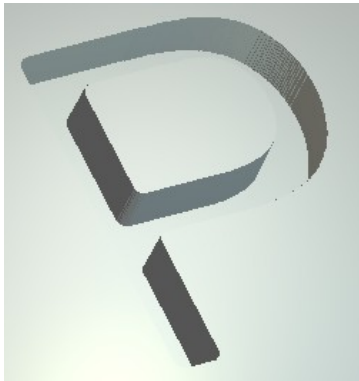

The **Inlay toolpath** has been generated. Note at the **corners** the **toolpath is rounded**. This is to ensure that it will be able to accommodate the **Male** insert.

- Select **Simulate Toolpath**.



If an **Inlay hole** was selected,  the depth of the **Inlay** is calculated from the material.

- Select **Reset Simulation**.



- From the **2D Toolpaths** page, select **Inlay**.



- In the **Inlay Wizard** page, select **Male Straight**.



- In the **Male Insert** page, Enter the same values and select the same tool as in the **Female Inlay Pocket** page.

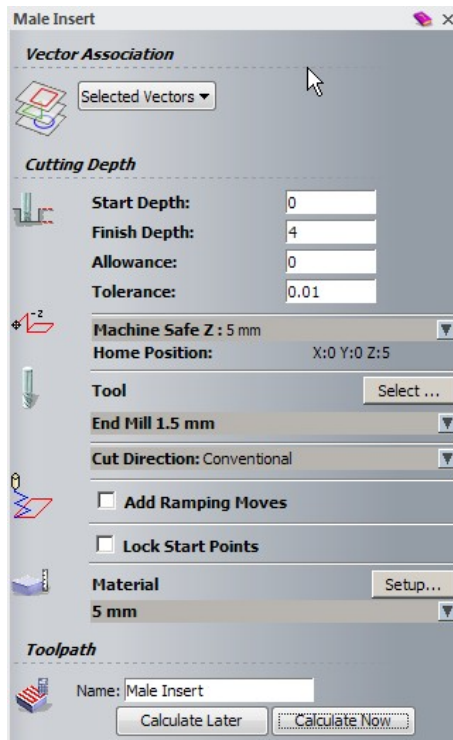

- Enter a **Finish Depth of 4mm.**
- **Locate** and Select the same **End Mill 1.5mm Tool.**
- Leave other options as shown
- Enter a name **Male Insert** and then select **Calculate Now.**

- Highlight **Male Insert Toolpath** and select **Simulate Toolpath.**



This **Male** insert will fit perfectly inside the female pocket.

Note: When you are generating **Stepped** inserts, the shoulder is offset from the vector, so with make inserts, this make the actual vector larger.

13. Nesting Vectors

Introduction

Nesting is an automatic procedure, which re-arranges the selected vectors within the first vector to use as little space as possible. This is especially useful if you require the maximum use of the material being used. Offsets for the tool radius and an offset between the toolpath are used, so there is enough room to machine out the vectors.

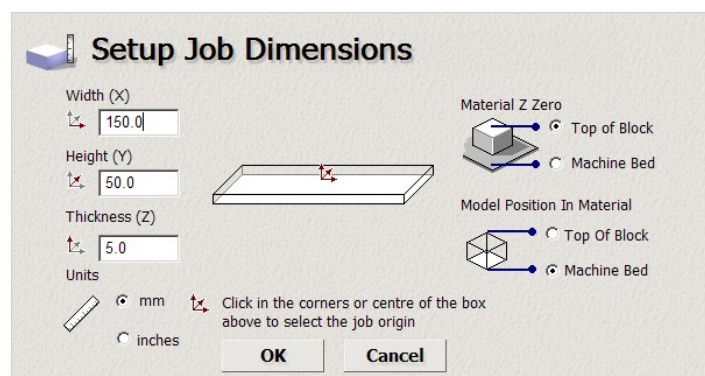

Nesting Vectors Exercise

- Create a New Model of Width 150mm, Height 50mm and Thickness of 5mm.
- Set the other options as shown below.



- Select **OK**.
- Create a **Rectangle** of **Width 145mm** and **Height 45mm** at a position of **X0 Y0**.
- Create and position the text  **all text to fit into this space**, using font **Bookman Old style**, size **10mm**.

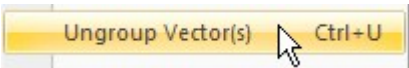

- Select the **Vector Text**, right mouse select the option **Ungroup Vector(s)** from the flyout menu.
- 
- Select both the **Rectangle (first)** and the **Text vectors**.
 - Select **Nest selected vectors**  from the **Vector Creation Toolbar**.
 - In the **Nesting** page, enter the values as shown in the image below.

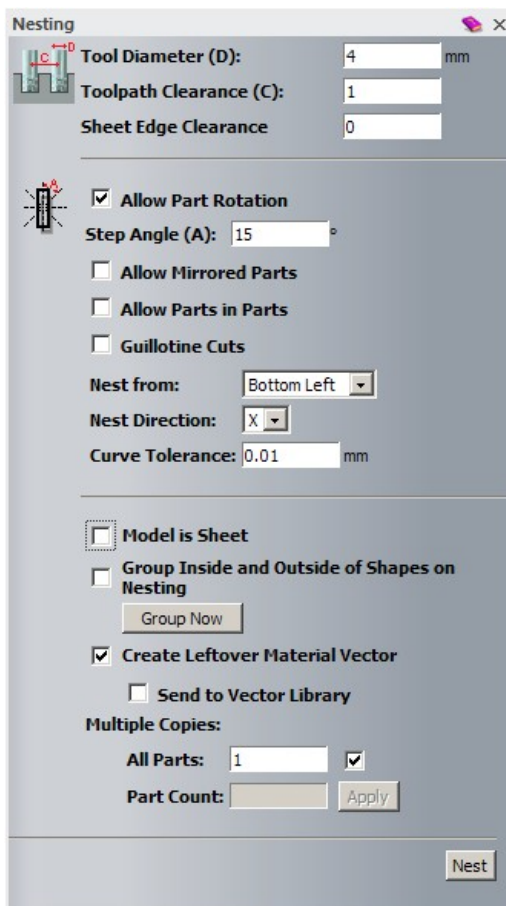

This page defines, what tool will be used and the **Allowance** between the toolpaths, to stop them overlapping.

To allow **ArtCAM Insignia** to find the optimum nesting, the Angle that the vectors can be rotated by can be set. If a step Angle of 10 degrees is chosen, each vector will be rotated by 10 degrees and then by another 10, until the optimum nesting is found.

Mirror parts and parts in parts are alternative Nesting options, which if suitable may nest the vectors more tightly.

- Select **Nest**.

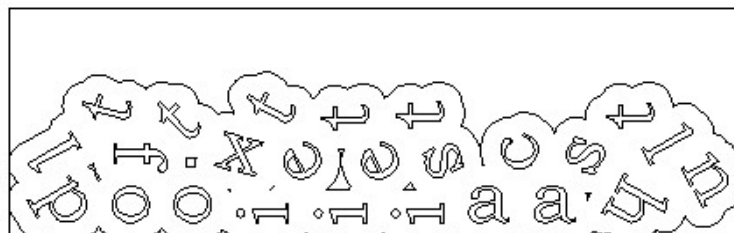

The leftover material vector is made up of several small bits and is therefore grouped together. This can be used later to define the boundary of the material remaining.

- **Close** the form.

- **Delete** the leftover material vectors.

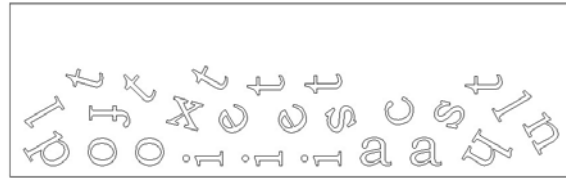

- Select **File - Save As** and enter a **file name** as **my-nest** in **D:\users\training\Coursework\ArtCAMPro-Jobs**.
- **Do not** close the model.

Re-ordering Toolpaths

A profile toolpath, with a lot of tool lifts, around the model, will not necessarily move in the order you require. A selected profile toolpath can be reordered where each lift appears.

- Select **all the text vectors** excluding the **rectangular outer vector**.
- In the **2D Toolpaths** tab, select **2D Profiling**. 

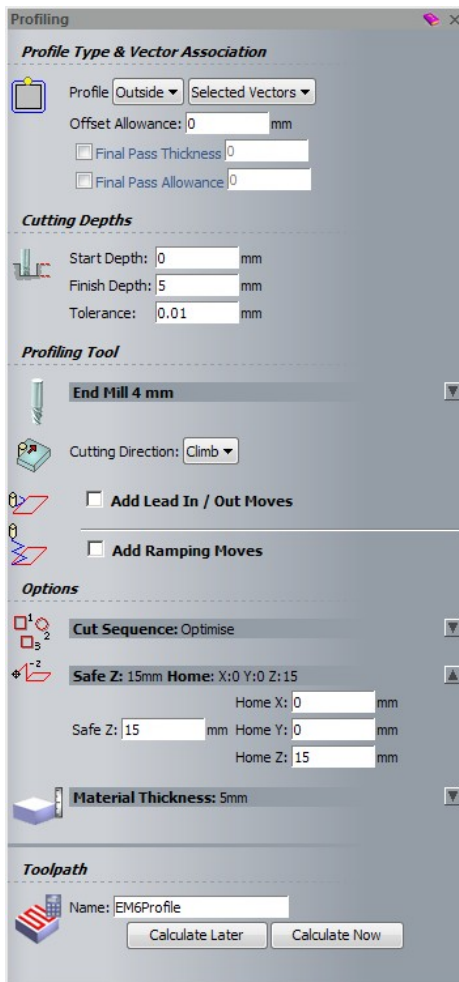

- Select **Outside**,
- Select a **Start Depth of 0**, and **Finish Depth of 10**.
- Select a **4mm End Mill tool** (you may need to create this tool).

The ordering sequence can also be defined here.

- Select **15mm for Machine Safe Z**, with the **Home Position at 0 0 15**.
- Name the Toolpath **EM4Profile**.

- Select **Calculate Now** and then **Close** the form.

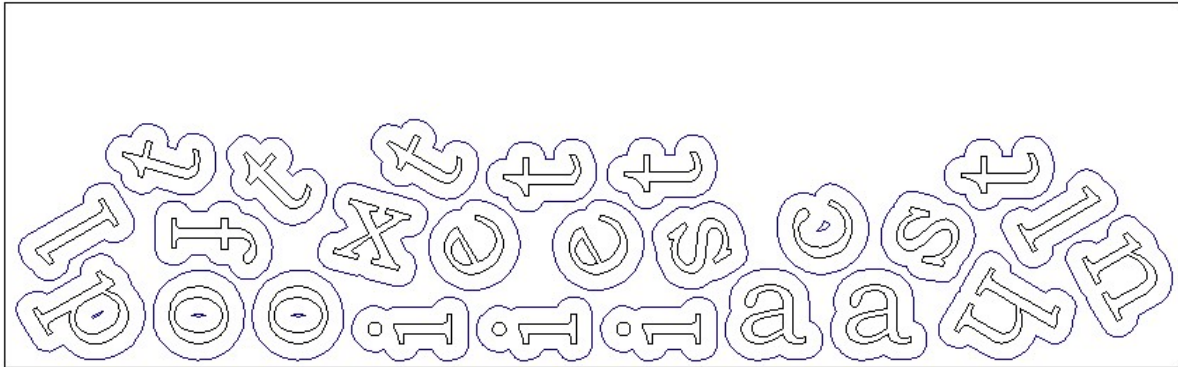

The vector group is machined. The order of machining can be modified to suit either from within the Toolpath or separately from the Toolpaths Tab.

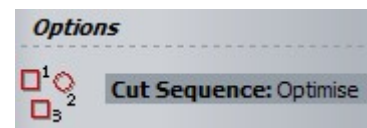

- In the **2D view**, select just the **Profiling** toolpath.

- From the **2D Toolpaths Tab**, select **Toolpath Ordering**.

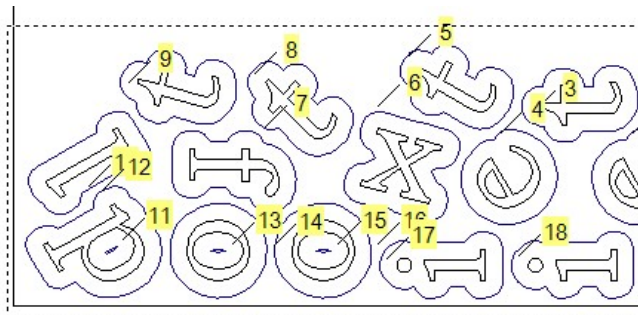
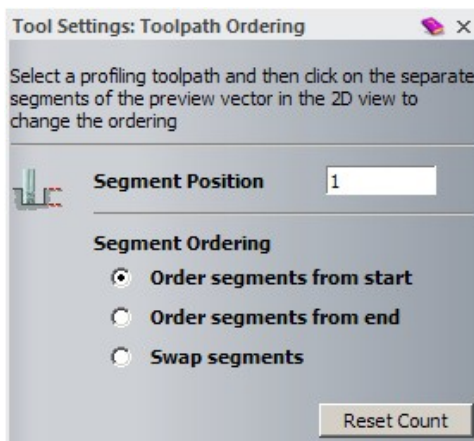

The toolpath ordering form appears and the current ordering is displayed on the toolpath.

With the segment position set at 1 you can manually pick each sector in turn and starting from one, renumber the segments. This can take some time if you have a lot of segments.



- Select **Order segments from start** to **re-order the toolpath**.
- Select the profile Toolpaths of individual letters to define the preferred path.
- **Close** the form.
- Simulate the toolpath to check the machining order.

14. Toolpath Panelling

Toolpath Panelling

Toolpath panelling will cut the ArtCAM toolpaths into panels sizes to suit your machine. It is important that the datum is set at the lower corner of the sheet. If the datum is elsewhere the model has to be move, the vectors moved and the toolpaths re-calculated.

Toolpath Panelling Exercise

- Open the model **train-breadbin-lid.art** from: D:\users\training\ArtCAM Data.
- Select **Simulate All Toolpaths**  to view the calculated toolpaths.
- **Draw**  the toolpaths over the simulation.

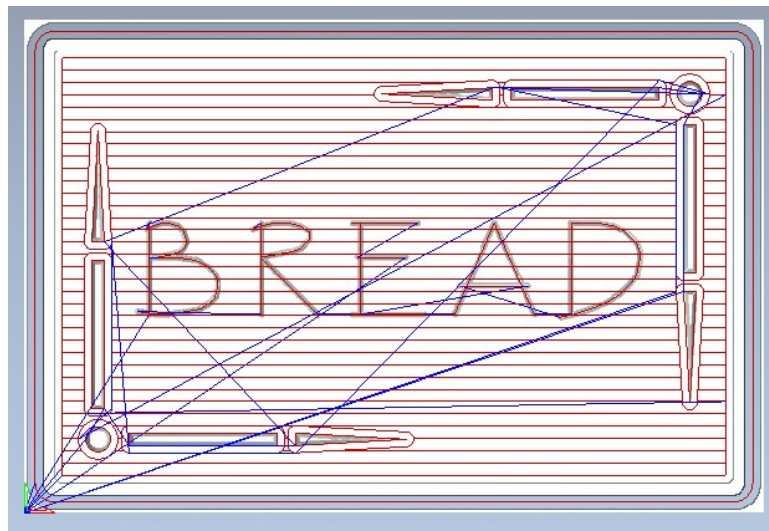

These toolpaths are going to be cut into panels using toolpath panelling.

- Switch to the **2D view**.

- From the **Toolpath Operations** tab, select **Toolpath Panelling**.



The panelling page appears. The sizes of the panels are set here and are displayed by dashed lines in the 2D view and a number in the middle of the panel.

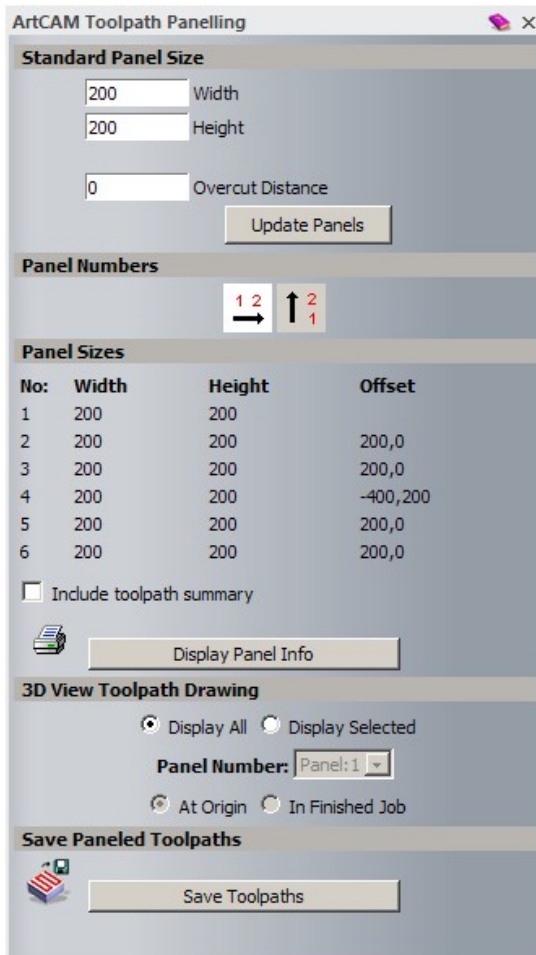

- Enter a **Panel Width of 200mm** and a **Height of 200mm**.
- Select **Update Panels**.

Selecting **Display Panel Info** produces a **HTML** summary which can be printed independently.

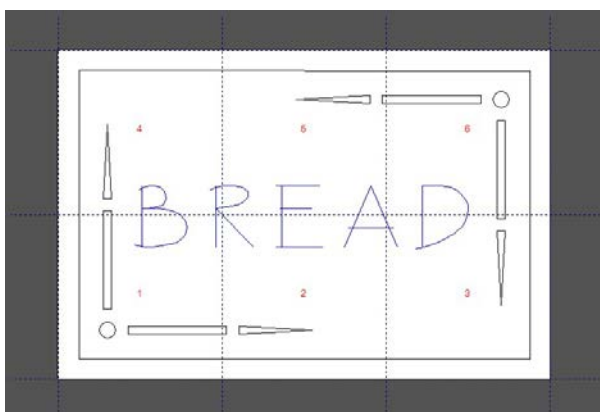

The panels can be seen clearly defined by the dashed lines. If required, the panels can be manually modified by dragging (for example if the panel goes through a feature in the wrong place)

- Drag the **panel borders** to avoid passing through the end of the side details as shown.

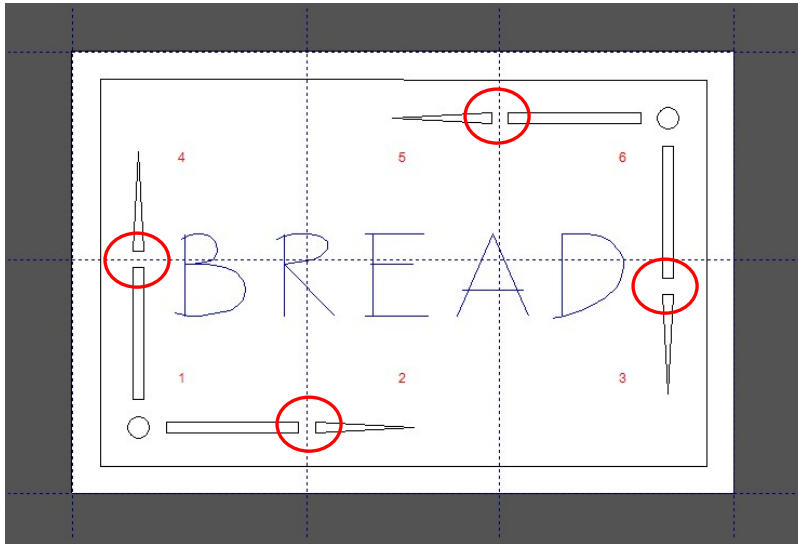

This is the best solution with reasonable panels of approximately the same size.

- Select **Horizontal Panel Numbers**  to update and reflect the new **Width** and **Height** panel sizes.

Panel Sizes			
No:	Width	Height	Offset
1	212.694	211.667	
2	174.367	211.667	212.694,0
3	212.939	211.667	174.367,0
4	212.694	188.333	-387.061,211.667
5	174.367	188.333	212.694,0
6	212.939	188.333	174.367,0

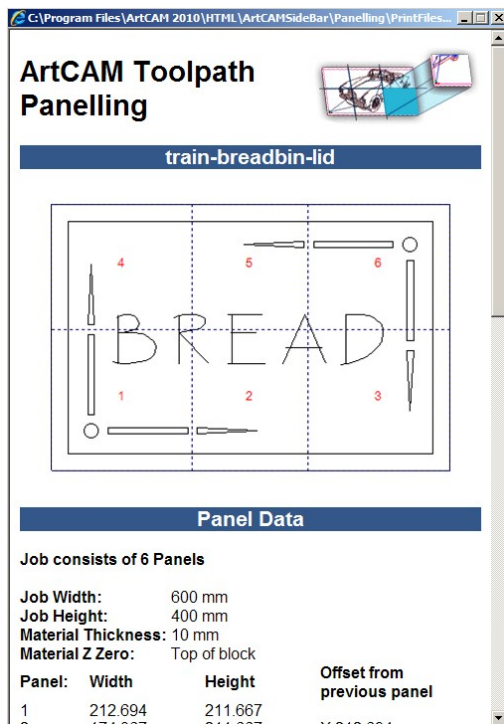

- Select **Include Toolpath Summary**.
- Select **Display Panel Info**.

An **html** file appears with the panel information on which can be printed.

- **Close** the **HTML** summary page.

- Select the **3D View**.
- Select **Display Selected** in the **3D view Toolpath Drawing**.
- Select **Panel: 2** and select **In Finished Job**.

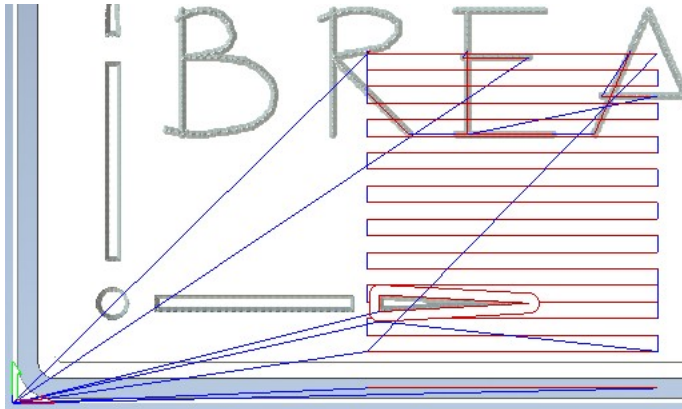
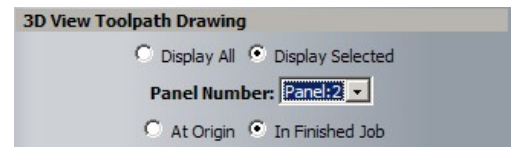

The toolpath is shown in the job with the extended toolmoves from the left corner datum.

- Select **Panel: 2** and Select **At Origin**.

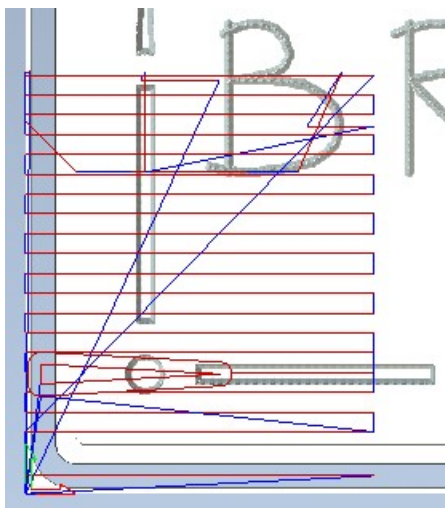
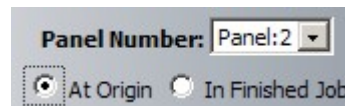

The toolpath is shown at the origin as if you put panel 2 in your machine.

All of the toolpaths in the panel are not displayed in the toolpaths list as there may be lots of them.

The toolpaths are saved to disc. The original toolpath is selected and then **ArtCAM** saves the panelled post processed toolpath as a named directory.

- Select **Save Toolpaths**.
- Select the **Area Clear** toolpath, a suitable Machine option and select **Save**.
- Enter the File name **Panelling** and press **Save**.

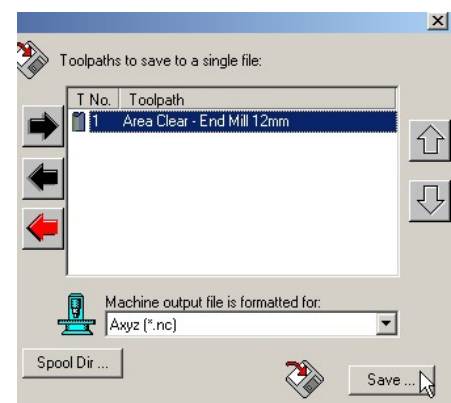
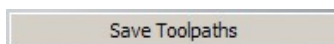

- **Locate** the directory into which the **post processed files were saved**.
- The **6 toolpaths** called **Panelling_P1** to **Panelling_P6** are generated for **panels 1 to 6**.

